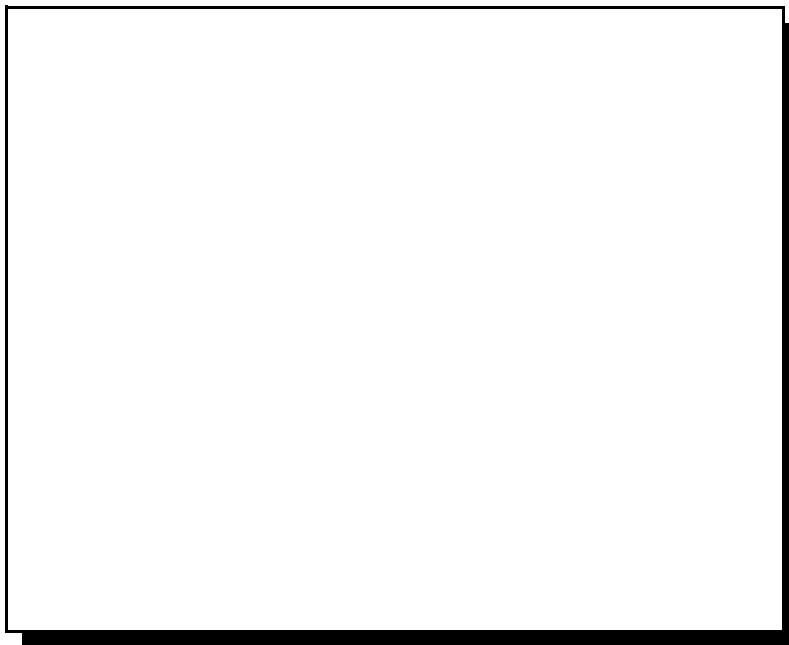


# **OPM 4000**

## Opacity/Dust Density Monitor





---

# OPM 4000 Opacity/Dust Density Monitor

## ESSENTIAL INSTRUCTIONS

### READ THIS PAGE BEFORE PROCEEDING!

Rosemount Analytical designs, manufactures and tests its products to meet many national and international standards. Because these instruments are sophisticated technical products, you **MUST properly install, use, and maintain them** to ensure they continue to operate within their normal specifications. The following instructions **MUST be adhered to** and integrated into your safety program when installing, using, and maintaining Rosemount Analytical products. Failure to follow the proper instructions may cause any one of the following situations to occur: Loss of life; personal injury; property damage; damage to this instrument; and warranty invalidation.

- **Read all instructions** prior to installing, operating, and servicing the product.
- If you do not understand any of the instructions, **contact your Rosemount Analytical representative** for clarification.
- **Follow all warnings, cautions, and instructions** marked on and supplied with the product.
- **Inform and educate your personnel in the proper installation, operation, and maintenance of the product.**
- **Install your equipment as specified in the Installation Instructions of the appropriate Instruction Manual and per applicable local and national codes.** Connect all products to the proper electrical and pressure sources.
- To ensure proper performance, **use qualified personnel** to install, operate, update, program, and maintain the product.
- When replacement parts are required, ensure that qualified people use replacement parts specified by Rosemount. Unauthorized parts and procedures can affect the product's performance, place the safe operation of your process at risk, **and VOID YOUR WARRANTY.** Look-alike substitutions may result in fire, electrical hazards, or improper operation.
- **Ensure that all equipment doors are closed and protective covers are in place, except when maintenance is being performed by qualified persons, to prevent electrical shock and personal injury.**

The information contained in this document is subject to change without notice.

## PREFACE

The purpose of this manual is to provide information concerning the components, functions, installation and maintenance of the OPM 4000.

Some sections may describe equipment not used in your configuration. The user should become thoroughly familiar with the operation of this module before operating it. Read this instruction manual completely.

## DEFINITIONS

The following definitions apply to WARNINGS, CAUTIONS, and NOTES found throughout this publication.

### **WARNING**

Highlights an operation or maintenance procedure, practice, condition, statement, etc. If not strictly observed, could result in injury, death, or long-term health hazards of personnel.

### **CAUTION**

Highlights an operation or maintenance procedure, practice, condition, statement, etc. If not strictly observed, could result in damage to or destruction of equipment, or loss of effectiveness.

### **NOTE**

Highlights an essential operating procedure, condition, or statement.

## SYMBOLS

 : EARTH (GROUND) TERMINAL

 : PROTECTIVE CONDUCTOR TERMINAL

 : RISK OF ELECTRICAL SHOCK

 : WARNING: REFER TO INSTRUCTION BULLETIN

### **NOTE TO USERS**

The number in the lower right corner of each illustration in this publication is a manual illustration number. It is not a part number, and is not related to the illustration in any technical manner.

## Table of Contents

	Essential Instructions . . . . .	i
	Preface . . . . .	ii
	Definitions . . . . .	ii
	Symbols . . . . .	ii
<b>SECTION 1</b>		
<b>Description and Specifications</b>		
	System Overview . . . . .	1-1
	Transmissometer/Retro Reflector . . . . .	1-1
	Control Unit . . . . .	1-1
	Optional Air Purge Weather Cover System . . . . .	1-1
	Alignment System . . . . .	1-1
	Cabling . . . . .	1-2
	Principle of Operation . . . . .	1-2
	Normal Mode of Operation . . . . .	1-2
	Internal Calibration System, Zero Mode . . . . .	1-2
	Internal Calibration System, Span Mode . . . . .	1-2
	Specifications . . . . .	1-4
<b>SECTION 2</b>		
<b>Installation</b>		
	Installation Considerations . . . . .	2-2
	Choose an Installation Site . . . . .	2-2
	Accessibility . . . . .	2-2
	Environment . . . . .	2-2
	Stack Exit . . . . .	2-2
	Mechanical Installation . . . . .	2-2
	Drawing Notes . . . . .	2-2
	Platforms . . . . .	2-2
	Alignment of Stack Flanges . . . . .	2-3
	Installation of Stack Flanges . . . . .	2-3
	Sample Area . . . . .	2-3
	Mounting the Air Plenum and Weather Covers . . . . .	2-4
	Transceiver and Retro Reflector Assembly . . . . .	2-5
	Beam Alignment Procedure . . . . .	2-6
	Air Flow Switch . . . . .	2-8
	Control Unit . . . . .	2-8
<b>SECTION 3</b>		
<b>Startup and Calibration</b>		
	Before Startup . . . . .	3-1
	Stack Exit Correlation Computation . . . . .	3-2
	Startup Service . . . . .	3-2
	Verifying Instrument Operation and Configuration . . . . .	3-2
	Edit Keys . . . . .	3-2
	Factory OPLR Display . . . . .	3-3
	Quick Menu . . . . .	3-3
	Zero/Span Calibration Check . . . . .	3-4

# OPM 4000

---

<b>SECTION 4</b>	OPM 4000 Operations and Adjustments . . . . .	4-1
<b>Operation</b>	Front Panel LED's. . . . .	4-1
	Fault Messages . . . . .	4-1
	Control Unit Manual Controls . . . . .	4-2
	Alarm Set Point Adjustments . . . . .	4-2
	Alarm Time Delay Adjustment . . . . .	4-3
	4-20 mA Outputs . . . . .	4-3
	Recorder or Other Device Calibration . . . . .	4-3
	Auto Cal Timer Adjustment. . . . .	4-3
	Remote Calibration Cycle Initiate . . . . .	4-4
	Remote Calibration Cycle Acknowledgment . . . . .	4-4
	Service Module . . . . .	4-4
<b>SECTION 5</b>	Clear on Stack Zero and Span Calibration . . . . .	5-1
<b>Zero and Span</b>	Zero Reflector Adjustment. . . . .	5-2
<b>Calibration</b>	Span Filter Mark . . . . .	5-3
	Record the Zero/Span Values in the Quick Menu . . . . .	5-4
	Off Stack Zero Calibration . . . . .	5-4
<b>SECTION 6</b>	Using the On Line Zero Reflector . . . . .	6-1
<b>On Line Zero Reflector</b>	Procedure . . . . .	6-1
<b>Option</b>	Filter Correction . . . . .	6-2
	Course Adjustments . . . . .	6-3
	Micro-turn Parts List . . . . .	6-3
	Filter Certification . . . . .	6-4
<b>SECTION 7</b>	Preventive / Corrective Maintenance Schedule. . . . .	7-1
<b>Maintenance</b>	Control Unit Preventive Maintenance . . . . .	7-3
<b>SECTION 8</b>	Troubleshooting. . . . .	8-1
<b>Troubleshooting</b>		
<b>SECTION 9</b>	Spare Parts . . . . .	9-1
<b>Replacement Parts</b>		
<b>SECTION 10</b>	Mounting: Under 6 ft (1,8 m) Diameter . . . . .	10-2
<b>Drawings</b>	Mounting: Over 6 ft (1,8 m) Diameter . . . . .	10-3
	Air Purge/Weather Cover Mechanical Installation. . . . .	10-4
	Panel Cutout for Control Unit. . . . .	10-5
	Control Unit Dimensions . . . . .	10-6
	Control Unit Terminal Identification . . . . .	10-7
	Typical System Wiring (Sheet 1 of 2) . . . . .	10-8
	Typical System Wiring (Sheet 2 of 2) . . . . .	10-9
	Transceiver and Retro Reflector Signal and Control Wiring . . . . .	10-10
<b>APPENDIX A</b>	Safety Instructions . . . . .	A-2
<b>Safety Data</b>		

---

# Section 1 Description and Specifications

---

---

System Overview .....	page 1-1
Principle of Operation .....	page 1-2
Specifications .....	page 1-4

---

## SYSTEM OVERVIEW

The OPM 4000 Opacity/Dust Density Monitor provides continuous, low maintenance, precision measurement of opacity and optical density in industrial applications. It is a cost-effective instrument that serves as an aid in operating pollution and/or process control equipment.

### Transmissometer/Retro Reflector

The OPM 4000 is a precision, double-pass, dual beam transmissometer that consists of a transceiver (transmitter/receiver) mounted on one side of a stack or duct and a passive reflector mounted on the opposite side. The light source, photo detectors, and all measurement/reference optics used in opacity measurement are housed in the transceiver.

The function of the reflector is to return the measurement beam to the detector in the transceiver, creating a double pass across the process stream. The standard reflector is used for measurement path lengths up to 15 feet (4,6 m). For longer path lengths, maximum 60 feet (18,3 m), reflectors, optical parts and electronics will vary.

### Control Unit

Mounted in a control room environment, the OPM 4000 control unit provides instrument control functions, opacity readings, alarms and fault indicators, analog outputs, and diagnostics with contact closures.

### Optional Air Purge Weather Cover System

The transceiver and reflector may be mounted in weather covers. The weather covers are fairly compact to allow movement around them even on a three-foot walkway or platform. They protect the stack-mounted components from dirt, moisture, stack temperatures within the specified ambient temperature limits, and errant air currents around the stack.

The air purge system constantly circulates air past the optical window. The airflow is directed through the hose to an air plenum on the stack side of the optical window. The airflow in the air plenum area results in reduced pressure and increased velocity. This venturi effect tends to continually draw the air around the optical window into the purge air stream, thereby keeping the lens clean for long periods.

### Alignment System

The OPM 4000 includes a built-in through-the-lens alignment system. The alignment target can be viewed through a window on the transceiver. Adjustments to changes in alignment are provided by a 3-point alignment system, which is integral to the air plenum.

# OPM 4000

---

## **Cabling**

The standard cabling used between the stack-mounted units and the control unit is at a minimum 6-pair, #20 AWG, twisted, shielded cable. More pairs or larger than 20 AWG is acceptable.

## **PRINCIPLE OF OPERATION**

### **Normal Mode of Operation**

The dual beam measurement system has a stack mounted transmissometer sensor system that consists of an optical transceiver mounted on one side of the stack and a retro reflector mounted on the other (Figure 1-1). To avoid errors due to ambient light, the lamp is electronically modulated and projects a collimated beam of light, which is split into a reference beam, and a measurement beam by an optical beam splitter. The reference beam is directed to the reference detector (RD). The measurement beam is projected across the stack to a retro reflector that returns the beam back across the stack to a beam splitter and directs the measurement beam to the measurement detector (MD). A portion of the returning light is also sent to the TTL (Thru The Lens) bulls-eye target viewed through a window provided at the rear of the transmissometer. The bulls-eye is used to correct changes in alignment and is unique in that no moving parts are used.

The ratio of the measurement and reference detectors is used to provide a transmittance<sup>2</sup> ( $T^2$ ) signal. Because the same light source is used for both detectors, and a measurement / reference ratio is used throughout for the calculations, the monitor is insensitive to variations in light intensity. Since all measurements are made on a ratio basis, all resulting computations are independent of the absolute intensity of the light source or contamination of the optics associated with the collection and focusing of the energy from the lamp. The ( $T^2$ ) signal is converted to a current format and sent to the control unit for processing. At the control unit the signal is processed to read 0-100% opacity, and provide alarms and outputs.

### **Internal Calibration System, Zero Mode**

Zero and span calibration checks can be initiated manually, automatically, or by a PLC or computer. During the zero calibration mode a calibrated zero reflector is placed in front of the transceiver optical package testing all optical surfaces and electronic components to assure zero point has not changed.

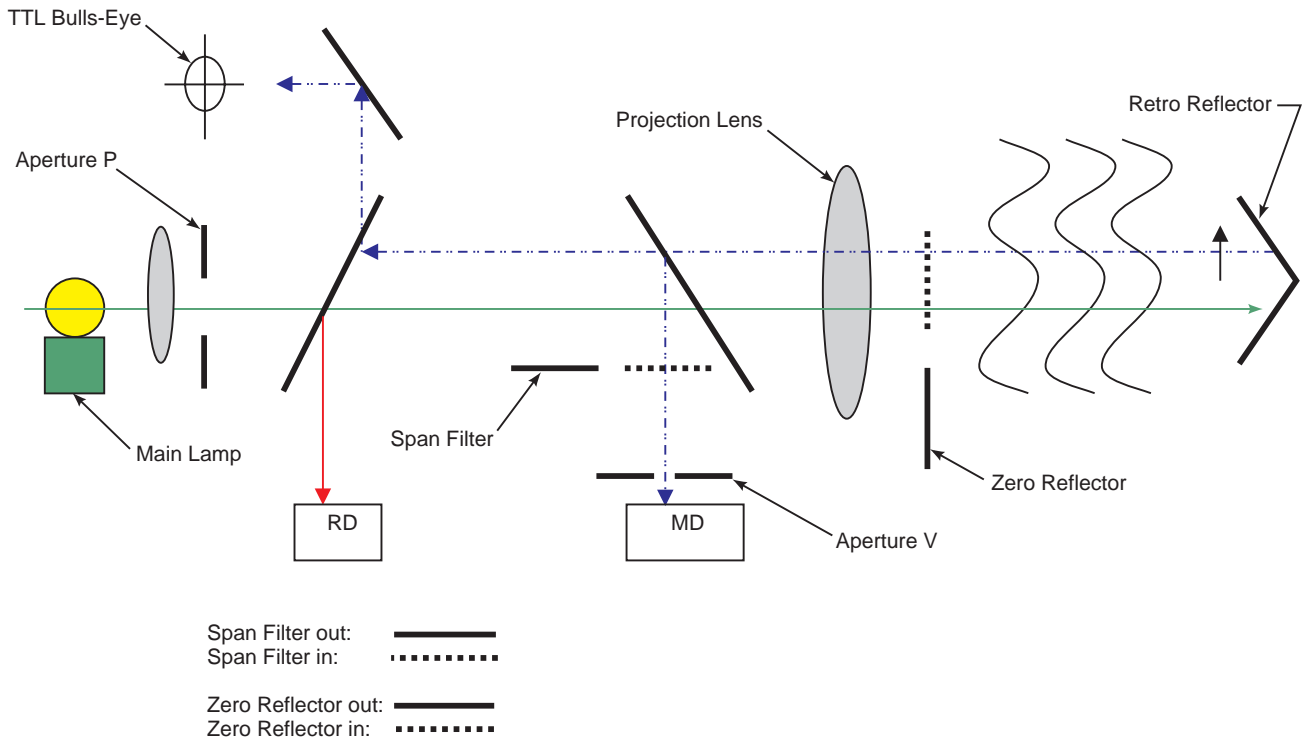
### **Internal Calibration System, Span Mode**

In the span mode a Span filter of known neutral density is placed in the measurement path and produces a specific up scale reading in accordance with the latest EPA requirements. The zero and span cycle provides a continuous check of all the optical components and surfaces, the main lamp, the detector, interconnecting wiring, control unit, and computation analysis.



Figure 1-1. Component Relationships

**TRANSCIEVER WITH AUTO ZERO SPAN CAPABILITY**



**SPECIFICATIONS**

<b>OPM 4000 Specifications</b>	
<b>Design and performance</b>	<b>Meets or exceeds PS-1 revised and ASTM D6216-98</b>
Peak and Mean Spectral Response	Photopic; 515 to 585 nm, less than 10% of peak response outside 400 to 700 nm
Relative Spectral Response	<10%
Angle of View	< 4.0° from optical axis
Angle of Projection	< 4.0° from optical axis
Calibration Error/Accuracy	±1% of full scale
Response Time	<10 seconds
Zero Drift	<0.5%
Calibration Drift	<0.5%
Operational Period	In excess of PS-1 required 336 hrs
Zero/Span Calibration	Manual or automatic with zero mirror and neutral density filter
<b>Remote control unit</b>	
Numeric Digital Display 5/8 in. (15,9 mm), 4-digit LED	Selectable for instantaneous opacity, average opacity, optional mg/m <sup>3</sup>
Display Resolution	0.1% Opacity
Alphanumeric 8 character LED (0.2 in.) Fault Display	Air purge low, No Stack Power, T2 4-20 Lost/low, Maintenance Mode, Window Dust, Zero Cal Fail, Span Cal Fail, Manual Cal.
Bargraph	Left/Right: 51 segments LED 5.1 in. (129,5 mm) for instant/average opacity. 20 segment LED 2.1 in. (53,3 mm) for window dust and drift in % opacity.
Operator Indicating LED's	Run, Alarm, Operate, Cal in progress
High Opacity Set Point	0-100% of full scale
High Opacity Delay	Adjustable 0-300 seconds
High Opacity Alarm Reset	Automatic
Open Transistor Collector Outputs	Four selectable
Dry Contacts	Two selectable (option: two additional)
Instantaneous Opacity and Average Outputs	4-20 mA grounded reference, 800 ohms max. (two additional optional)
OPLR (Exit Correlation Lx / 2*Lt)	0.2 to 3.0
Cal Cycle initiate	Local, remote and timed adjustable 1 to 24 hours
Enclosure	NEMA 13, IP65, Height: 7.38 in. (187,5 mm) x Width: 3.00 in. (76,2 mm) x Depth: 7.75 in. (196,9 mm), Weight 6 lbs (2,24 kg)
Ambient Temperature Range	32° to 122°F (0° to 50°C)
Power Requirements	120 VAC (±15%), 50/60 Hz, 22VA
Network	Protocol: Modbus (ASCII or RTU mode), type RS-485, optically isolated
Configuration	Speed: 300-38,400 baud, type RS-232
<b>Transceiver Service module</b>	
Display	5/8 inch (15,9 mm), 4-digit LED, selectable for % opacity and % transmittance
Local Zero/Span	Manual on demand
Test Jacks	Transceiver to remote control current loop
Diagnostics	Loss of power, current loop open, maintenance mode

**OPM 4000 Specifications**

**Transceiver/Reflector**

Enclosure	NEMA 4 watertight enclosure
Path Length	2 to 15 ft (0,6 to 4,6 m). Longer available
Optical System	Double pass
Light Source Aging Compensation	Automatic
Light Source Life	> 5 years
Ambient Temperature Limits	-4° to 131°F (-20° to 55°C)
Process Gas	Up to 750°F (400°C), standard (higher available-contact factory)
Alignment Verification	Passive built-in through-the-lens system
Mounting Flanges	3 in. IPS, 150 lbs (56 kg) pipe flange
Ambient Light Immunity	Solid-state electronic light modulation



## Section 2 Installation

---

Installation Considerations .....	page 2-2
Mechanical Installation .....	page 2-2
Mounting the Air Plenum and Weather Covers .....	page 2-4

---

**⚠ WARNING**

Before installing this equipment, read the "Safety instructions for the wiring and installation of this apparatus" in Appendix A. Failure to follow safety instructions could result in serious injury or death.

**⚠ WARNING**

Install all protective equipment covers and safety ground leads after installation. Failure to install covers and ground leads could result in serious injury or death.

**⚠ WARNING**

Before making any electrical connections, make sure the AC power supply is first switched off. Failure to do so could cause personal injury or even death. Make sure that the voltage and frequency of the AC supply match the designations on the analyzer component tags.

## INSTALLATION CONSIDERATIONS

### Choose an Installation Site

The primary considerations for choosing a site for the OPM 4000 is accessibility, ambient environmental conditions, and locating the unit to obtain a representative sample of the process. The following general guidelines should be considered.

### Accessibility

Locate the instrument where it will provide safe access for periodic maintenance and inspection. A platform or walkway is required for access to the sensors and weather covers.

### Environment

Locate the stack-mounted units in an area with ambient temperatures between  $-4^{\circ}$  to  $+130^{\circ}\text{F}$  ( $-20^{\circ}$  to  $54^{\circ}\text{C}$ ). (Consult the factory for other temperature ranges.) Areas that are clean and dry are desirable. Avoid areas with condensation.

Maintenance intervals are directly related to the installation environment. Intervals can vary from 2 to 3 months in fairly clean environments, to twice a month in dirty environments. Lens cleaning is a function of the ambient conditions and cleanliness of the purge air.

Locate the instrument to avoid excessive vibration or shock.

Locate the control unit in an easily accessible area with temperatures between  $32^{\circ}$  to  $122^{\circ}\text{F}$  ( $0^{\circ}$  to  $50^{\circ}\text{C}$ ). To permit the operator to read and/or change controls, the unit should not be mounted higher than five feet from floor level.

### Stack Exit

It is recommended to locate the transceiver at least two stack diameters from the stack exit.

## MECHANICAL INSTALLATION

### Drawing Notes

A review of the drawings and procedures provided will help to produce an error free installation. However, there are important additional points that must be observed. The beam of the instrument must be kept in a horizontal plane; the transceiver cannot be rotated more than  $\pm 10^{\circ}$  from vertical. The weather covers must be installed vertically level.

Installation and wiring diagrams are found at the end of this manual. Please review all drawings prior to starting installation or wiring.

### Platforms

A platform or walkway must be available for access to the weather covers. The optimum condition is to have the mounting flanges and weather covers approximately 5 feet (1,5 m) above the floor. A minimum of 12 in. (305 mm) from the bottom of the weather cover to the floor is required in order to remove the air filters. Railings and other obstructions should allow the weather cover to swing clear as shown in the installation drawings.

## **Alignment of Stack Flanges**

Stack flange alignment is described in Installation of Stack Flanges and is the first step in successful installation. The final beam alignment adjustments are described in the Beam Alignment Procedure.

## **Installation of Stack Flanges**

For an opacity monitor, the customer is required to supply and install two 3 in. IPS flanges at eye level directly across from each other. The flange faces, mounted on pipe stubs, should be approximately 6 to 8 in. (152 to 203 mm) from the stack or insulation. On completion of the installation, the flanges must be aligned so that the total deviation of the light source flange relative to a common centerline does not exceed  $\pm 1^\circ$  and the retro reflector flange does not exceed  $\pm 3^\circ$ .

Flanges should be mounted approximately 5 feet (1,5 m) up from the deck of the platforms, roof or walk way.

At installations where conditions permit, this may be accomplished by using a piece of 2-1/2 in. (63,5 mm) pipe suspended across the stack protruding far enough to allow slipping the 3 in. flange pipe assemblies over each end and welding in place as shown in Mounting: Under 6 ft (1,8 m) Diameter drawing in Section 8.

Any deviation up to the previously specified limits can be adjusted during the installation and alignment of the light source and retro reflector with the system's alignment adjustments.

Where installations do not permit the use of the method mentioned above, the following procedure will accomplish the same results. (See Mounting: Over 6 ft (1,8 m) Diameter drawing in Section 8). An alignment tool can be purchased from the factory to ensure accurate alignment.

Accurately locate one 3-1/2 in. (89 mm) diameter hole (large enough to accept the 3 in. pipe) and the other hole approximately 1/2 in. (12,7 mm) diameter, directly across from each other. Attach the alignment tool to the flange/pipe assembly and insert the pipe into the 3-1/2 in. (89 mm) hole in the stack wall. Align the assembly with the 1/2 in. (12,7 mm) diameter hole on the opposite side by viewing through the alignment tool and weld the pipe in place. Care must be exercised when welding to maintain alignment.

The 1/2 in. (12,7 mm) diameter hole should now be enlarged approximately 3-1/2 in. (89 mm) to accept the other flange/pipe assembly. Proceed in the same manner, installing the assembly with the alignment tool attached, and weld in place maintaining concentric alignment with the 3 in. pipe previously installed on the opposite wall.

## **Sample Area**

To achieve a representative sample, the accepted practice is to have the measurement path of the instrument directly in the center of the stack. An area should be chosen where the gases are not stratified in the stack or duct.

When installed near a bend, install the transceiver in the plane defined by the bend. Avoid locations where large amounts of condensed water may be present.

## MOUNTING THE AIR PLENUM AND WEATHER COVERS

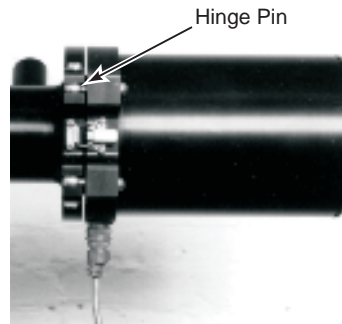
**⚠ WARNING**

Control unit, Transceiver and Retro serial numbers must match.

After the installation site has been selected and the platform requirements have been met, the mounting flanges should be installed and aligned as described in Section 2, Installation of Stack Flanges. Flanges should be installed with the mounting faces on the vertical plane.

1. Before installing the transceiver, retro reflector, or any type of weather cover, remove the air plenum from both the transceiver and retro reflector. Removal will make the installation easier with less chance of damage while attaching the air plenums and optional weather covers when provided.

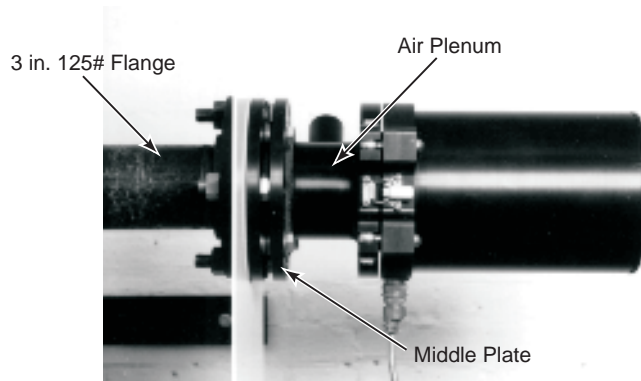
Figure 2-1. Transceiver and Retro Reflector Hinge Pins



2. If the transceiver and retro reflector have been shipped from the factory with the air plenum attached, un-clip both hold down latches, swing open and lift up and off the hinge pins (Figure 2-1). Place the transceiver and retro in a safe place.
3. The air plenum is attached to the customer supplied 3 in. pipe flange by four 2-1/2 in. (63,5 mm) long 5/8-11 bolts. Working from the 3 in. flange, assemble the gasket then air plenum.
4. If you have weather covers remove the two weather cover hood hinge pins located on the upper right and left hand corner of the hood. The air plenum and weather cover are attached to the 3 in. pipe flange by four 2-1/2 in. (63,5 mm) long 5/8-11 bolts (Figure 2-2). Working from the 3 in. flange, assemble the gasket, weather cover mounting plate, gasket, and mating flange, and air plenum. Place the 5/8-11 bolt through the top hole of the middle plate. Place a flat washer between the middle plate and mating flange and pass the bolt through. Slip a split lock washer over the bolt and secure with a nut. Repeat for the remaining three mounting bolts.
5. Connect any wiring or air hoses.

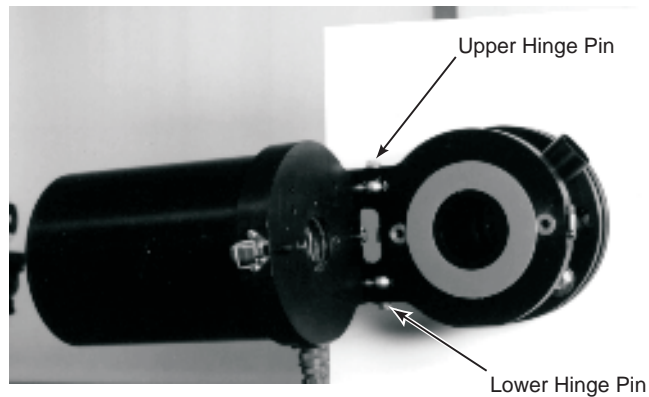


Figure 2-2. Air Plenum



### Transceiver and Retro Reflector Assembly

Figure 2-3. Upper and Lower Hinge Pins



1. Attach the transceiver and retro reflector to the air plenum assembly by placing them on the hinge pins (Figure 2-3).

2. Close transceiver and retro and secure in place with the two hold down latches.
3. The air-purge blowers should be powered up at this time to prevent stack particulate from accumulating in the nipple and air-purge housing.

#### **⚠ CAUTION**

If installed location has a positive pressure the air-purge system must be used continuously during installation to prevent process gases from contaminating optical surfaces or over heating instrument electronics. If the system is shut off for more than momentary interruptions, the instrument may be damaged. Failure to provide continuous air-purge may void the warranty.

All wiring from the control unit to the transceiver should be completed at this time.

## BEAM ALIGNMENT PROCEDURE

### NOTE

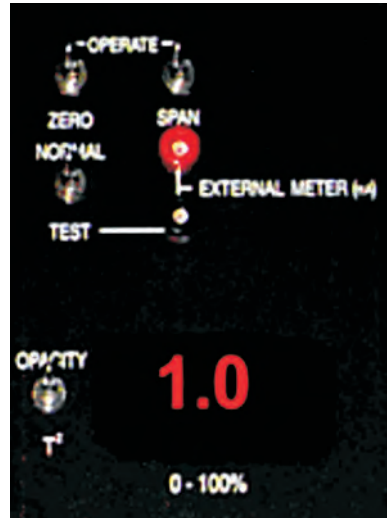
Alignment can not be done unless the power is applied to the stack mounted service module. The control unit does not have to be connected or powered. For alignment accuracy, the stack should be at normal temperature.

### NOTE

Alignment should be completed before instrument calibration. For alignment accuracy, the stack should be at normal temperature.

Maintenance module switches (Figure 2-4) should be in the normal type operating positions.

Figure 2-4. Service Module  
Switch Location

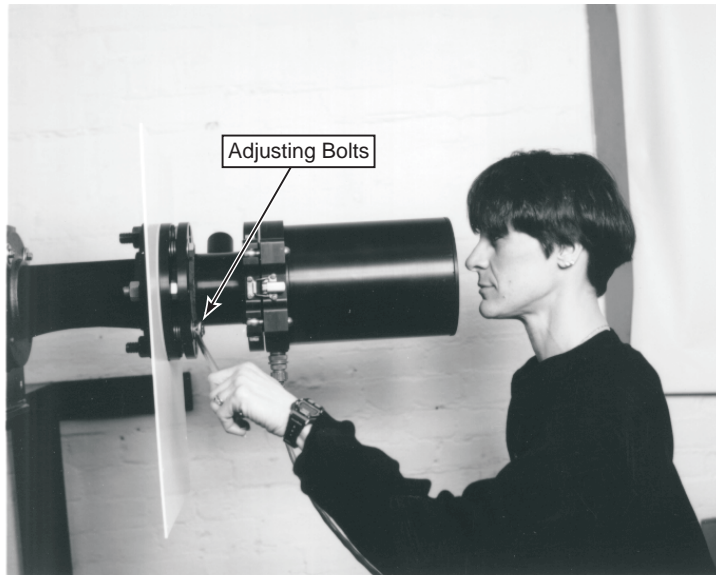
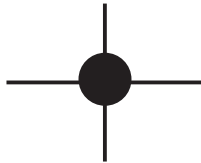


- Zero/Operate - Operate
- Span/Operate - Operate
- Normal/Test - Normal
- Opacity/T<sup>2</sup> - Opacity

1. If not already on, turn on the power to all air purge systems and service module.
2. Align the reflector mating flange so it is level and parallel to the 3 in. 150 lb mounting flange. Use the 3 adjusting bolts on the air purge plenum flange until this is accomplished. The adjusting bolts have nylon locking inserts to prevent loosening by vibration.

3. Move to the transceiver, and determine monitor alignment by looking through the viewing port located on the rear of the transceiver and observing whether the beam image is in the center of the cross hair (bulls-eye) as shown in Figure 2-5.

Figure 2-5. Alignment of the Transceiver.



# OPM 4000

## Air Flow Switch

If you have an airflow alarm when the system is powered, check the airflow switch. With the blower running and the source under normal conditions, disconnect the leads of the switch and place an ohmmeter across them. The switch should be closed, less than 2 ohms, if flow is enough to over-come stack pressure and blower inlet is clear. Cover the air cleaner inlet and verify the switch opens. Replace the leads when the test is complete.

## Control Unit

Mount the control unit (Figure 2-6) at eye level for best viewing of the display.

Cut out for panel mounting is shown in the drawing section. Insert the control unit through the cut-out hole. Insert the panel mounting hardware in the slots provided in the top and bottom of the control unit from the rear. Tighten the screws until the control unit is securely held in place.

Wire the control unit per drawing section and energized power.

Figure 2-6. Control Unit



---

## Section 3 Startup and Calibration

---

---

Before Startup .....	page 3-1
Stack Exit Correlation Computation .....	page 3-2
Startup Service .....	page 3-2
Verifying Instrument Operation and Configuration .....	page 3-2
Edit Keys .....	page 3-2
Factory OPLR Display .....	page 3-3
Quick Menu .....	page 3-3
Zero/Span Calibration Check .....	page 3-4

---

### BEFORE STARTUP

You must complete the following before startup is attempted.

1. Measure and record flange-to-flange distance to verify it is the same as the final check out sheet.
2. If you are using a recorder, DAS, etc., **DO NOT CONNECT THEM NOW**. Outputs and inputs from other sources should be left off until system has been completely checked according to the following instructions. After system operation has been verified, connect and test external connections.
3. Read the instructions first to familiarize yourself with the instrument before attempting startup.
4. The air purge and weather cover system, transceiver, retro reflector, and service module must be installed and power applied.
5. Control unit must be installed and wired to the service module and customers equipment as applicable.
6. All wiring and mechanical installations must be complete per drawings provided in this manual. All wiring must be checked and power applied to both the control unit and the stack maintenance module.
7. Beam alignment procedure has been completed.

# OPM 4000

---

## **STACK EXIT CORRELATION COMPUTATION**

1. The stack exit correlation is especially important to verify. If possible, all dimensions should be verified by actual measurements.
2. Measure and record inside stack dimensions at the measuring point and at the stack exit, and compute the Optical Path Length Ratio (OPLR). Check that the calculated and the OPLR found in the Factory OPLR, and the Check step found further in this section, are within  $\pm 2\%$ .
  - Lx = Stack exit inner diameter, Lt = Inner diameter of the effluent path.
  - Example: A stack with a 120 in. (3048 mm) stack exit ID and a 120 in. (3048 mm) pathlength.

$$OPLR = \frac{Lx}{Lt} \qquad OPLR = \frac{120}{2*120} = 0.50$$

## **STARTUP SERVICE**

Rosemount Analytical is available to assist you; call our Customer Support Center (CSC) at 1-800-433-6076 for details and to schedule startup.

## **VERIFYING INSTRUMENT OPERATION AND CONFIGURATION**

Alignment procedure must be completed as outlined in Section 2.

Apply power to both the control unit and the sensors for a minimum of 30 minutes before any adjustments are attempted.

Observe the front panel LED's and confirm the red Operate and the green RUN LED's are on. Press the ACK button to confirm NO ALM'S message is displayed. Press the DIS button until OPACITY % is displayed.

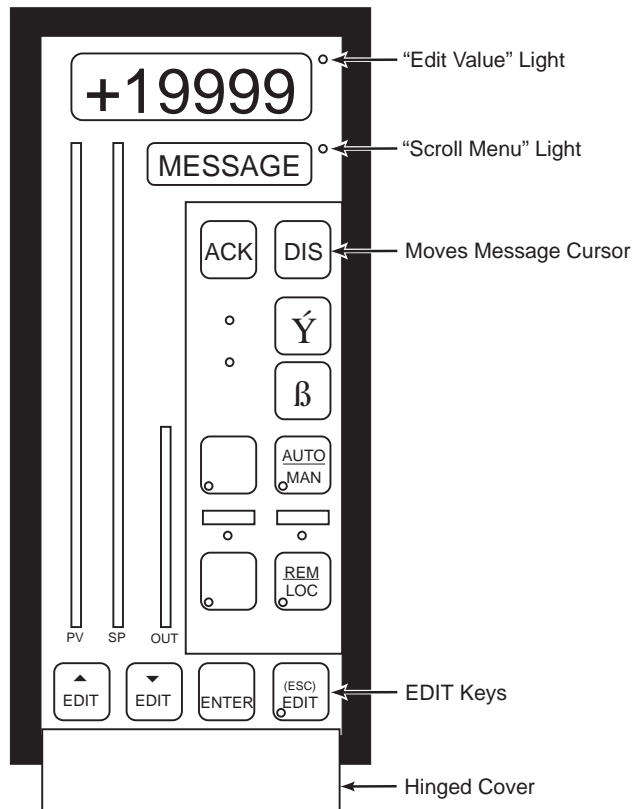
## **EDIT KEYS**

All data entry, editing, and diagnostics are accomplished with four EDIT keys behind the hinged cover.

**FACTORY OPLR DISPLAY**

Under the flip down door, press the **EDIT (ESC)** button [the red Edit (ESC) LED will light]. The message display will read QUICK MENU. Press the **ENTER** key, then the **EDIT ↓** key or hold and scroll down until the Display reads "OPLR Read Only". Press the **ENTER** key; the OPLR is displayed. This is a read only block and cannot change the OPLR of the system. It is intended for a convenient place to record the OPLR. The OPLR is factory set and cannot be changed in the field. If an OPLR change is required, contact the factory for return authorization number and shipping instructions.

Figure 3-1. OPLR Display



**QUICK MENU**

- Alarm Set Point                      In % opacity
- Alarm Time Delay                    In Seconds
- Auto Cal Cycle Time                In hours
- Zero Cal Value                        In % opacity
- Span Cal Value                        In % opacity
- OPLR Read Only                        XX.XX

**ZERO/SPAN  
CALIBRATION CHECK**

The zero calibration has been set at the factory by placing the instrument on an optical bench using the flange-to-flange dimensions specified by the customer and recorded in the customers final test report. This zero value is critical as it can offset smoke measurement plus or minus if not correctly set. The measurement reflector contains an aperture that is chosen during the factory calibration and is fixed. The transceiver is aligned with the beam centered on the retro reflector and the electronics is adjusted to produce a zero opacity value.

The calibration zero reflector is then adjusted to provide a low value - typically 1-2% and the span filter up scale value is recorded. The values are entered in the Quick Menu under "Zero Cal Value" and " Span Cal Value". When the system enters a manual or auto cal check cycle, the current zero and span values are checked against the stored values. If either the zero or span current value exceeds the stored value by  $\pm 2\%$  opacity, the fault system will energize.

To verify initiate a manual cal cycle by pushing the AUTO/MAN key. The Alarm LED will light and the Left/Right Bargraph will blink, this is normal because a manual cal is considered a fault condition. Pressing the ACK key will cause the ALARM LED and the bargraphs to stop blinking. The message display will read MANUAL CAL ALARM. Push the DIS key to return to display opacity.

After the cal cycle is complete pushing the ACK key should clear any alarms. If no alarms are present the system is working properly.



## Section 4      Operation

---

<b>OPM 4000 Operations and Adjustments</b> .....	<b>page 4-1</b>
<b>Service Module</b> .....	<b>page 4-4</b>

---

### OPM 4000 OPERATIONS AND ADJUSTMENTS

The OPM 4000 consists of transceiver, retro reflector, service module and the control unit. The maintenance module has a digital display for reading opacity from the control unit and T2 from the transceiver. It also has connections for attaching a meter for troubleshooting or calibration when necessary. Other switches are provided for initiating zero and span modes during service or maintenance. If any switch causes the system to read other than stack opacity, the Control unit Fault Alarm system will be energized notifying the operator. A fault output signal (open transistor collector) is also energized for use with other alarms or DAS system, which need to know opacity readings are not representative of the actual stack opacity and a fault condition exists.

**Only two conditions are considered normal operation;** 1- Reading smoke, 2- Computer or internal clock initiated calibration check cycle.

### Front Panel LED's

**ALARM** - Red LED is blinking when a fault is detected. Manual Cal.

**RUN** - Green LED is on during normal operation and blinking if system is in S/M mode. The primary reason for S/M mode is to prevent 4-20 mA outputs from changing when user is modifying blockware.

**OPERATE** - Red LED is on during normal operation.

**AUTO/MAN** - Red LED is on during calibration check mode.

**ZERO** - Red LED is on when zero cal cycle is in progress, out during span or normal operation.

**SPAN** - Red LED is on when span cal cycle is in progress, out during zero or normal operation.

**HIGH OPACITY** - Red LED is on if opacity exceeds set point for more than the time delay (typically 30 seconds).

**REM/LOC** - Red LED always out (this is not used).

### Fault Messages

**Air purge low** - Airflow to the transceiver and/or retro reflector is not sufficient.

**No Stack Power** - Indicates loss of service module power loss or other related power or component failure from the service module.

**T2 4-20 Lost/low** - Transceiver 4-20 mA current loop is out of specification or missing.

**Maintenance Mode** - Indicates a maintenance mode switch on the service module is in a position and the system is not displaying or outputting the smoke reading.

**Window Dust** - Dirt has accumulated on the transceiver lens and/or the zero mirror in excess of the > 5% limit and must be cleaned.

**Control Unit Manual Controls**

**Alarm Set Point Adjustments**

**Zero Cal Fail** - During calibration check the zero reading has exceeded the > 2% opacity set point.

**Span Cal Fail** - During calibration check the span reading has exceeded the > 2% opacity set point.

**Manual Cal** - A manual calibration check from the control unit front panel AUTO/MAN key was pressed.

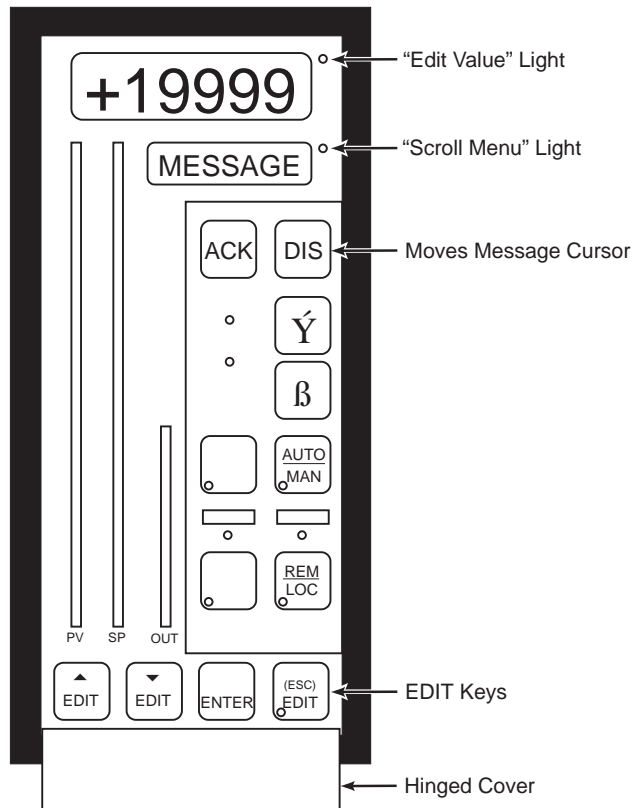
**ACK** - Acknowledges fault alarms and displays the fault message.

**DIS** - Changes display each time it is pressed; Opacity %, Average Opacity, dust/zero shift, hours to next cal.

**AUTO/MAN** - initiates a maintenance cal cycle and resets calibration cycle timer clock.

Under the flip down door, press the **EDIT (ESC)** button [the red Edit (ESC) LED will light]. The message display will read QUICK MENU. Press the **ENTER** key, then the **EDIT ↓** key 1 time until the Display reads ALARM SET POINT. Press the **ENTER** key twice; the Edit Value Light will flash. Press and hold the **EDIT ↑** or **EDIT ↓** key until the desired set point in % opacity value is displayed, i.e. 20.00 is 20.00% opacity. Press the **EDIT** key 4 times to return to normal operation (Figure 4-1).

Figure 4-1. OPLR Display



### Alarm Time Delay Adjustment

Under the flip down door, press the **EDIT (ESC)** button [the red Edit (ESC) LED will light]. The message display will read QUICK MENU. Press the **ENTER** key, then the **EDIT ↓** key 2 times until the Display reads ALARM TIME DELAY. Press the **ENTER** key twice, the Edit Value Light will flash. Press and hold the **EDIT ↑** or **EDIT ↓** key until the desired time in seconds is displayed, i.e. 15 is 15 seconds delay. Press the **EDIT** key 4 times to return to normal operation.

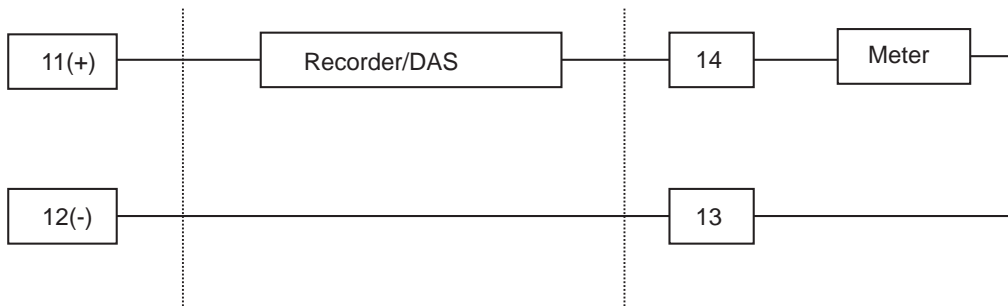
### 4-20 mA Outputs

The OPM 4000 comes with two 4-20 mA outputs (Figure 4-2). The ranges are set during final test to the information supplied by the customer.

Maximum output Loop compliance is 800 ohms.

AOUT1 (instantaneous opacity, zero/span when in check mode) is connected at terminal **11 and 12** and supplies the opacity signal to a recorder or DAS and to the service module for display at the sensor location.

Figure 4-2. 4-20 mA Outputs



AOUT2 [average opacity, zero/span when in check mode] is connected at terminal **13 and 14**.

No calibration is necessary; however, if you want to check that other devices such as recorders or DAS are responding correctly use the following procedure.

### Recorder or Other Device Calibration

On the control unit front panel press the AUTO/MAN key for a maintenance zero and span cycle. Both outputs will correspond to the opacity display value.

### Auto Cal Timer Adjustment

Under the flip down door, press the **EDIT (ESC)** button [the red Edit (ESC) LED will light]. The message display will read QUICK MENU. Press the **ENTER** key, then the **EDIT ↓** key 3 times or scroll down until the Display reads AUTOCAL CYCL TMR. Press the **ENTER** key twice, the Edit Value Light will flash. Press and hold the **EDIT ↑** or **EDIT ↓** key until the desired set point in hours is displayed, i.e. 24.00 equals 24 hour intervals. Press the **EDIT** key 4 times to return to normal operation.

# OPM 4000

---

## Remote Calibration Cycle Initiate

To have an external device cause the monitor to begin calibration cycle, connect an N.O. dry contact to terminal 8L and 9. A momentary closure will initiate a 3-minute zero and a 3-minute span check cycle. Total time of calibration check is 6 minutes.

## Remote Calibration Cycle Acknowledgment

Cal in progress - By dry contacts on terminal 4U (common) and 5U (NC). This contact remains closed until cal is completed, i.e. both zero and span.

## SERVICE MODULE

The service module is used to pass signals to and from the transceiver and control unit, display opacity via digital meter, initiate maintenance zero and span cycles and insertion of external current meter in the transceiver to control unit 4-20 mA loop.

**OPACITY / T2** - This switch selects the display of the stack digital meter. In the opacity mode the digital displays % opacity from the control unit. In the T2 mode it is the signal out of the transceiver in % Transmittance<sup>2</sup>.

**OPERATE / ZERO** - This switch controls the zero mirror solenoid. In the operate position the mirror is not in the measuring path and is considered normal operation. When the mirror solenoid is energized, the mirror is placed in the measurement path and is considered a maintenance condition, i.e. signal is not representative of the stack smoke. The control unit will indicate a fault.

- Energize and observe the digital meter to test the systems response to zero % opacity.
- Energize in conjunction with the span filter to observe the up scale span % opacity calibration point.

**OPERATE / SPAN** - This switch controls the span filter solenoid. In the operate position the span filter is not in the measuring path and is considered normal operation. When the span filter solenoid is energized, the span filter is placed in the measurement path and is considered a maintenance condition, i.e., signal is not representative of the stack smoke. The control unit will indicate a Fault.

- Energize in conjunction with the zero mirror to observe the up scale span calibration point.

**NORMAL / TEST** - This switch controls the EXTERNAL mA METER connections. In the normal mode the terminals are shorted. In the test mode the terminals are open and the current loop from the transceiver is interrupted allowing the use of an external current meter to be placed in series with the transceiver current output. When this is in the test mode position it is considered a maintenance condition and fault condition. If no current meter is in the test jacks, the loop current the control unit will indicate will be full scale and the control unit will indicate a fault.

# Section 5 Zero and Span Calibration

---

Clear on Stack Zero and Span Calibration .....	page 5-1
Zero Reflector Adjustment .....	page 5-2
Span Filter Mark .....	page 5-3
Record the Zero/Span Values in the Quick Menu .....	page 5-4
Off Stack Zero Calibration .....	page 5-4

---

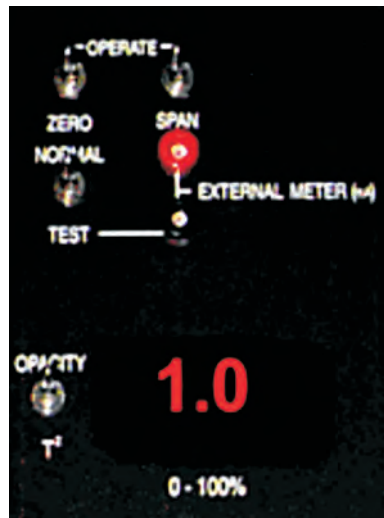
## CLEAR ON STACK ZERO AND SPAN CALIBRATION

A clear stack condition must exist to perform this calibration. Power must have been on for no less than 30 minutes. Do not attempt these adjustments in inclement weather. After the cover is removed from the transceiver normal levels of day light in the area will not effect the calibration.

To complete this procedure the following items are required: Micro-turn 200 on-line test kit with a high filter of at least 0.8 OD.

1. Swing both the retro and transceiver open and clean the protective windows (Figure 5-3). Return both to the closed position.
2. Verify alignment; returning beam is centered on the TTL target.
3. On the transceiver remove the screw below the target viewing window and pull the housing straight back until it clears the optical plate.
4. On the service module (Figure 5-1) make sure the normal/test switch is in the normal position.

Figure 5-1. Service Module

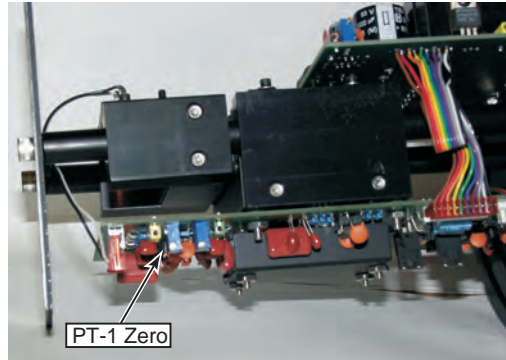


**NOTE**

All adjustments are on the signal processor PC Board (Figure 5-2).

5. Adjust the 20 turn zero potentiometer marked "PT -1", clockwise for an up-scale reading >15%, then slowly counterclockwise for 0-1% opacity.

Figure 5-2. Zero Calibration

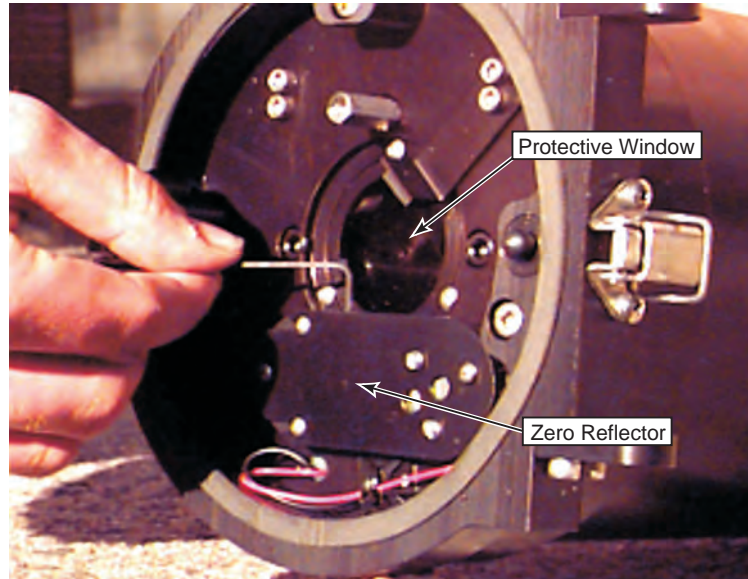


6. Install the Micro-turn 200 on-line test reflector on the transceiver and screw the device to the transceiver with the mounting screw. With the thumbwheel, adjust the on-line reflector for the same opacity as in previous step and lock it in place.
7. Place the highest value filter (for best results at least an 0.8 OD) in the slot provided. Adjust the span potentiometer marked "PT-3" for the filters correlated value on the service module opacity display until it is equal to the correlated value. See Section 6 for filter correlation formulas.
8. Remove the filter and adjust the zero potentiometer PT-1 for 0-1%.
9. Insert the high filter and adjust PT-3 for its value; repeat steps until the values come within 0.5% opacity.
10. Remove the on-line test reflector and replace the transceiver cover and secure the transceiver in place. You must complete Zero Reflector Adjustment procedure next.

**ZERO REFLECTOR  
 ADJUSTMENT**

1. After clear, or off stack zero, has been performed the zero reflector needs to be adjusted.
2. Find and record the zero offset value found in the QUICK MENU under Zero Cal Value, see Zero/Span Calibration Checks in Section 3 for procedure to access the quick menu.
3. Place the Opacity/T<sup>2</sup> switch on the service module in the opacity position to observe the correlated opacity on the digital display.
4. Swing open the transceiver and initiate a zero with the zero switch on the service module to raise the zero reflector into place. Observe and record the zero value after 30 seconds. Return the mirror to normal resting position by returning the zero switch to operate position.

Figure 5-3. Zero Reflector



5. Insert a 1/16 in. Allen wrench into the adjustment set screw located on the top of the zero reflector (Figure 5-3). Turn set screw clockwise 1/8 turn.
6. Remove the Allen wrench and initiate a zero utilizing the zero switch on the service module and after 15 seconds make sure the reading is moving toward the desired value. (If value is away from that desired, repeat step 5 and turn set screw counterclockwise).
7. Repeat steps 4 and 5 each time for making small 1/8-turn increments until the desired value is reached. Cycle 2-3 times more waiting 15 to 20 seconds between cycles to ensure unit repeats desired value  $\pm 0.5\%$  opacity. Record the final value; you will need to enter it into the Zero Cal Value in the QUICK MENU.
8. Swing transceiver into operate position and secure in place.

## **SPAN FILTER MARK**

1. With the zero switch in zero, place the span switch in span. Span is not adjustable. Final value is a function of filter value, transceiver calibration, and OPLR. Record the final value; you will need to enter it into the Span Cal Value in the QUICK MENU.
2. Return both zero and span switches to operate, normal/test to normal, T<sup>2</sup>/Opacity to opacity.

## RECORD THE ZERO/SPAN VALUES IN THE QUICK MENU

1. At the control unit, under the flip down door, press the **EDIT (ESC)** button [the red Edit (ESC) LED will light]. The message display will read QUICK MENU. Press the **ENTER** key, then the **EDIT ↓** key 4 times or hold and scroll down until the display reads ZERO CAL VALUE. Press the **ENTER** key twice, the Edit Value Light will flash. Press and hold the **EDIT ↑** or **EDIT ↓** key until the zero value recorded in the previous steps is displayed. Press **ENTER** then press the **EDIT** key 3 times to return to normal operation.
2. Press the **EDIT (ESC)** button [the red Edit (ESC) LED will light]. The message display will read QUICK MENU. Press the **ENTER** key, then the **EDIT ↓** key 5 times or hold and scroll down until the display reads SPAN CAL VALUE. Press the **ENTER** key twice, the Edit Value Light will flash. Press and hold the **EDIT ↑** or **EDIT ↓** key until the span value recorded in the previous steps is displayed. Press **ENTER** then press the **EDIT** key 3 times to return to normal operation.
3. This completes the calibration.

## OFF STACK ZERO CALIBRATION

This procedure may be used if: A clear stack condition is not possible and the zero appears to be incorrect or if the flange-to-flange distance on site are different than the original factory set up.

1. Remove the transceiver and retro reflector from the hinge pins. Remove the service module and install the system on test stands and at the correct flange-to-flange distance plus 11 in. (279,4 mm). The additional 11 in. (279,4 mm) compensates for air plenum spacing, as the air plenums are not used for the off stack zero calibration. If test stands are not available, an alternate method is to use 3 in. pipe flanges with air plenums installed, contact the factory for air plenum availability. Set the spacing between the 3 in. flanges exactly the same as flange-to-flange measurement.
2. Clean transceiver and retro windows.
3. Connect the control unit with the control to service module test cable kit and apply power to the system.
4. The retro reflector must be level.
5. Follow instruction for Clear on Stack Zero and Span Calibration.



# Section 6 On Line Zero Reflector Option

Using the On Line Zero Reflector . . . . . page 6-1

## USING THE ON LINE ZERO REFLECTOR

The Micro-turn 200 on-line test and audit system may be used for:

- Opacity audit
- Linearity checks and adjustments
- System accuracy verification
- Service on-line or off-stack

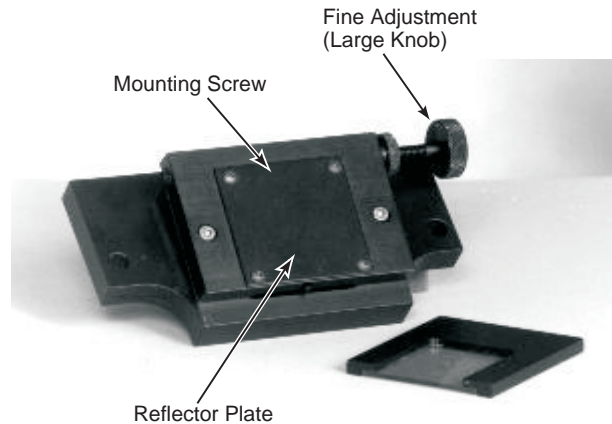
The Micro-turn 200 on-line test and audit system contains a test reflector, three neutral density filters, filter certification certificates and carrying case. The Micro-turn 200 on-line test reflector is inserted over the transceiver lens.

## Procedure

The Micro-turn 200 (Figure 6-1) on-line test reflector is inserted over the transceiver lens. The filters provided are marked in single-pass opacity, this is the same as double-pass with a correlation factor (OPLR) of 0.50.

1. Hold the Micro-turn in a position so as to see the reflector. Turn the fine adjustment (large knob) in a direction, which will open the iris to expose more of the reflector. This direction will cause the monitor to lower opacity and by turning in the opposite direction, closing the iris, will raise the opacity.

Figure 6-1. Micro-Turn 200



2. Loosen clamps on the transceiver and swing it open and clean the lens. Use alcohol with a clean lint free paper and leave no film on the lens.
3. Place the Micro-turn 200 with the reflector facing toward the transmissometer (away from the stack) on the two alignment pins and screw the device to the transceiver with the mounting screw.

4. Using the fine adjustment (large knob) start by raising the opacity level above zero, then slowly turn the knob in the opposite direction to just reach ZERO. If you cannot reach zero, or you cannot come above zero, see Course Adjustment section of this manual.
5. Place the neutral density slides in the slot provided on the top of the device just behind the mounting screw. The system should read the same value written on the label  $\pm 2\%$  or better.

**Filter Correction**

If you have an OPLR (correlation factor) other than 0.5, your slides will read differently. To calculate what the slide will read with another OPLR use the following formula:

$$\left( 1 - \left( \left( 1 - \frac{Op1}{100} \right)^{\frac{M2}{0.5}} \right) \right) * 100 = OP2$$

Where:

OP1 = Standard filter value in %

M2 = OPLR for your instrument

OP2 = Standard filter value at your OPLR in %

Example:

Standard filter value is 23.1%. Find what it will read at OPLR of 1.5.

$$\left( 1 - \left( \left( 1 - \frac{23.1}{100} \right)^{\frac{1.5}{0.5}} \right) \right) * 100 = 54.5\%$$

Filter re-calibration is available from Rosemount Analytical and if not regulated by EPA regulations in your State to a more frequent schedule we suggest you re-calibrate once a year at a minimum. If you have filters from other manufacturers we can calibrate them as well (call for pricing). Filters are tested per USA Code of Federal Regulations 40CFR60 Appx. B, Performance Specification 1, Section 7.1.3 Attenuation Calibration.

## Course Adjustments

**Opacity is below zero** and you can not reach zero after you have turned the adjustment knob as far as it will go into the Micro-turn housing — perform the following procedure:

### ⚠ CAUTION

Do not force the knob at the first sign of binding; STOP.

1. Hold the Micro-turn in your hand so you can see the iris and retro reflector. Turn the fine adjustment knob so that the iris is closed as far as it will go.
2. Loosen the course adjustment set screw.
3. Turn the fine adjustment knob in the opposite direction as far as it will go then tighten Allen set screw located on the bottom of the COM block. Be sure not to tighten more than 1/16 of a turn to prevent damage to the iris ring.
4. After the setscrew is tight, again try to reach zero. Repeat if necessary.

**Opacity is above zero** and you can not bring it up after you have turned the adjustment knob as far as it will go into the Micro-turn housing — perform the following procedure:

### ⚠ CAUTION

Do not force the knob at the first sign of binding; STOP.

1. Hold the Micro-turn in your hand so you can see the iris and retro reflector. Turn the adjustment knob so that the iris is open as far as it will go. CAUTION: Do not force the knob at the first sign of binding STOP.
2. Loosen the course adjustment set screw.
3. Turn the fine adjustment knob in the opposite direction as far as it will go then tighten Allen set screw located on the bottom of the COM block. Be sure not to tighten more than 1/16 of a turn to prevent damage to the iris ring.
4. After the setscrew is tight, again try to reach zero. Repeat if necessary.
5. You have tried all of the steps above and you can not reach zero or zero is unstable; contact the factory for assistance.

## Micro-turn Parts List

Part Number	Description
1395	2 in. (50,8 mm) square neutral density filter (certified and traceable to NIST)
1626	Iris 1.9 x 1.34 in. (49 x 34 mm)
1163	1/4-20 x 2-1/2 in. Adjustment knob
1164	Lock nut

## **Filter Certification**

QA/QC testing by Rosemount Analytical of the filters at an interval of not more than 6 months is recommended. Filter certification, replacement, or additional neutral density filters are available from Rosemount Analytical.

Rosemount Analytical neutral density filters for Micro-turn 200 are calibrated on a Perkin-Elmer Lambda Series 6 / PECSS Spectrophotometer per Federal Environmental Protection Agency specifications. These specifications are contained in the Code of Federal Regulations 40 CFR 60, Appendix B, Performance Specification 1, Attenuator Calibration. The filters are scanned over the visible region from 380 to 780 nanometers in one nanometer step and the resulting transmittances of the filter are weighted to the Source C Human Eye Response by multiplying each value by its associated response factor. The corrected values of transmittance are converted to % opacity and the value is recorded on the filter and associated chart.

# Section 7 Maintenance

Preventive / Corrective Maintenance Schedule . . . . . page 7-1  
Control Unit Preventive Maintenance . . . . . page 7-3

**⚠ WARNING**

Install all protective equipment covers and safety ground leads after equipment repair or service. Failure to install covers and ground leads could result in serious injury or death.

## PREVENTIVE / CORRECTIVE MAINTENANCE SCHEDULE

### Preventive/corrective maintenance schedule

#### Daily

- Check Zero/Span marks are within specification ( $\pm 2\%$ )
- Check for fault conditions

#### Monthly or as required

- Clean transceiver and retro windows
- Check alignment, correct if necessary
- Check air filters, replace if necessary

#### Quarterly

- All daily and monthly checks
- Perform COM Audit per EPA regulation 40 CFR, 60 App. B, PS-1.
- Replace air filters
- Check all air hoses and clamps for tightness and wear, correct as necessary
- Check weather cover gaskets for leakage
- Check all bolts for tightness
- Check that all electrical connections are secure
- Check the air blower for excessive noise
- Ensure that airflow switch is operating properly

#### Yearly

- Clear stack or off stack zero
- All quarterly checks
- Remove transceiver and retro, clean air plenum
- Replace any worn hoses and gaskets
- Clean inner optics if necessary
- Check all system operations
- General

**Preventive/corrective maintenance schedule**

**Yearly**

Corrective and preventive maintenance schedules should be adjusted according to site specific conditions to ensure the maximum availability of accurate measurement data. Routine checks should be implemented to:

Observe and correct the operation of the air-purge system giving particular attention to keeping the optical path within the mounting flanges clear of dirt build-up.

Observe and correct the operation of peripheral accessory equipment such as recorders, computers, etc.

Observe and correct the stack zero measurement whenever a clear stack condition exists. Care should be exercised to ensure that both transmittance and opacity measurements are at their prescribed values.

Verify that instrument operating manuals are available and that maintenance logs are properly maintained and reviewed.

**Every 2 Years**

Return to factory for in-depth cleaning of optics, optical alignment, and clear condition zero and testing to ensure system is working to specifications.

You may contact Field Watch. Field Watch coordinates Rosemount Analytical field service throughout the U.S. and abroad.

Phone: 1-800-654-RMST (1-800-654-7768)

Rosemount Analytical may also be reached via the Internet through e-mail and the World Wide Web:

e-mail: GAS.CSC@emersonprocess.com

World Wide Web: www.raihome.com

## CONTROL UNIT PREVENTIVE MAINTENANCE

Preventive maintenance consists of cleaning the instrument regularly and inspecting it occasionally for broken or damaged parts. Regular maintenance will improve the reliability of your instrument and prevent break downs.

**Cleaning** - Accumulations of dirt and dust on components act as an insulating blanket preventing efficient heat dissipation. Dust on circuit boards and wires can cause arcing and short circuits resulting in damage to components or even instrument failure. Clean your instrument with clean high-pressure air before this happens.

The control unit chassis provides protection from dust and dirt and should be in place during normal operation of the instrument.

**Exterior** - Dust the chassis with a soft cloth. Dust the front panel with a soft paintbrush. Dirt clinging to the surface can be removed with a soft cloth dampened with a mild detergent and water solution. Avoid using abrasive cleaners, as they will scratch the housing and front panel.

**Interior** - Dust in the interior of the control unit should be removed before it builds up enough to cause arcing and short circuits during periods of high humidity. Dust is best removed from the interior by the type of canned air used for computer cleaning. Dirt clinging to the surfaces can be removed with a soft paintbrush.

**Visual Inspection** - Inspect the interior occasionally for broken connections, improperly seated semiconductors, damaged or improperly installed circuit boards, heat damaged components, etc. If heat damaged components are found, care must be taken to find the cause of the excessive heat and measures must be taken to prevent recurrence of the damage.

**Semiconductor Checks** - Periodic checks of the semiconductor devices in this instrument are not recommended. The best check of semiconductor performance is actual operation of the instrument.

Weather cover/blower preventive maintenance.

**Periodically** - Check and inspect all hoses and wire connections inside the weather covers.

**Air Filter** - Empty the collection container at the bottom of each air filter. Remove the filter by turning the key to loosen the band holding it in place. Pull the container down and remove the rubber insert to empty any heavy particles. Before replacing, unscrew the wing nut holding the filter cartridge in place. It should be exposed to view where you removed the container. Remove and inspect, and clean or replace the filter cartridge as necessary.





# Section 8 Troubleshooting

Troubleshooting ..... page 8-1

## TROUBLESHOOTING

Problem	Possible Cause	Remedy
Control unit reads 100%, both bargraphs are blinking, Alarm LED is on, fault message T2 4-20 mA lost/low, service module meter in T2 reads -20 or higher.	Transceiver current loop to the control unit is open	Operate/test switch must be in Operate.  Check wiring for open from Terminal 17 and 18 on control unit to terminal 17 and 16 at service module location.
Alignment is good but control unit reads high opacity or erratic in normal, zero, and span mode; service module meter in opacity reads high or erratic.	Reference voltage TP-2 on signal processor is lower than 9.3V	Adjust lamp drive PT-2 on the power modulator until reference voltage TP-2 on signal processor is 10.0 Volts.
	Main lamp out	Replace main lamp assembly.
Control unit reads high, zero/span values are OK	Smoke	Correct process.
	Alignment is out	Adjust alignment until centered on target.
High dust alarm and /or cal fail cal message	Transceiver window and/or zero mirror is dirty	Clean window and/or zero mirror.
Control unit reads high, zero/span values are OK, alignment is good	Dirt built up in flanges	Swing open transceiver and retro. Clean flanges with push rod.
Air purge fault message	No, or low, air flow	Replace air blowers as necessary.
		Replace air filters as necessary.
		Tighten hose clamps as necessary.
No stack power fault message	Service module lost power or failed	Check power, check SM fuse. Replace as needed.
Maintenance Mode message	Maintenance switch or maintenance function is on	Return all to operate or neutral positions and press ACK key to clear alarms.
	Control unit zero/span key was pressed	
	Service module zero/operate switch in zero, span/operate switch in span	
Control unit blank	Control unit fuse open	Service module test/operate switch in test
		Replace and check for shorts in the power supply or individual boards.



# Section 9 Replacement Parts

Spare Parts ..... page 9-1

## SPARE PARTS

**Level I**, General maintenance supplies recommended for all users.

**Level II**, Back up critical printed circuit boards and parts suggested permitting rapid return to service if corrective maintenance is needed. Level II is recommended in addition to Level I for those users requiring maximum instrument availability.

**Level III**, If you cannot operate your facility without a monitor in operation. Level III is recommended in addition to Level I.

Qty	P/N	Description
<b>Level I</b>		
1 per plant	1232	Micro-turn 200 on-line test reflector kit, 3 filters and case.
1 per inst.	1466	Retro latch, spring and gasket repair kit. Optional air purge spares.
1 per 4 inst. or 1 per plant	1258	Standard air purge blower, min 5 CFM @ 36 in. H2O, max 36 CFM @ 2 in. H2O
1 per 4 inst. or 1 per plant	1885	Air flow switch assembly for air purge blower.
<b>Level II</b>		
1 per 4 inst. or 1 per plant	2555	CPU board.
1 per 4 inst. or 1 per plant	2556	Backup Memory Module, 8kx8 EEPROM.
1 per 4 inst. or 1 per plant	2372	Zero reflector iris assembly with rotary solenoid, retro tape and zero arm.
1 per 4 inst. or 1 per plant	1668	Power/modulator board.
<b>Level III</b>		
1 per 4 inst. or 1 per plant	1366	Stand by compliance OPM 4000 control unit, service module, transceiver and retro 3-15 ft (0,3 - 4,6 m).
<b>Tools</b>		
1 per 4 inst.	XXXX	4 Pack of air filter replacements, contact the factory for p/n
	1234	Opacity test stands.
	1073	Control unit to service module 10 ft (3,05 m) test cable.
	1078	Flange alignment tool.



---

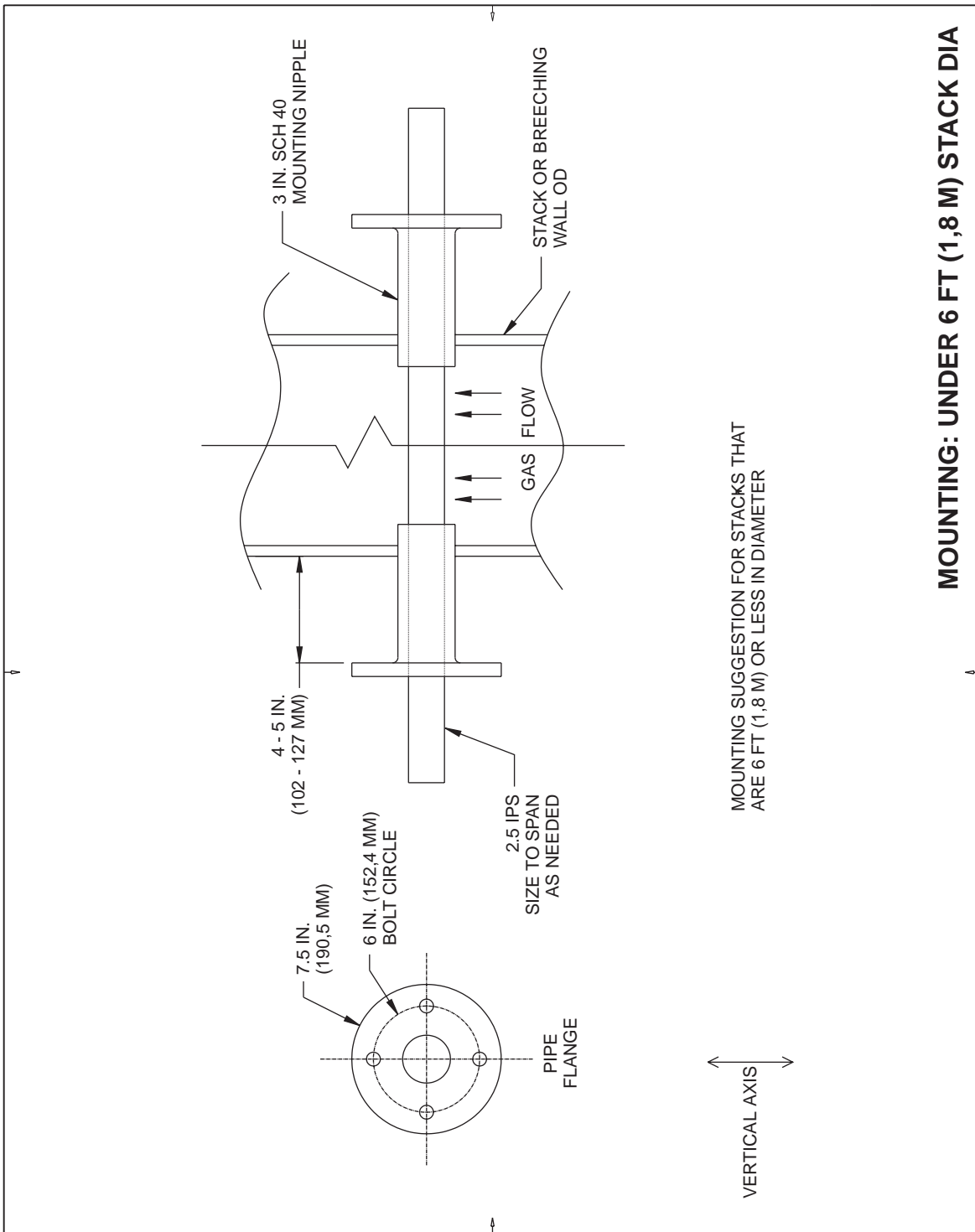
## Section 10 Drawings

---

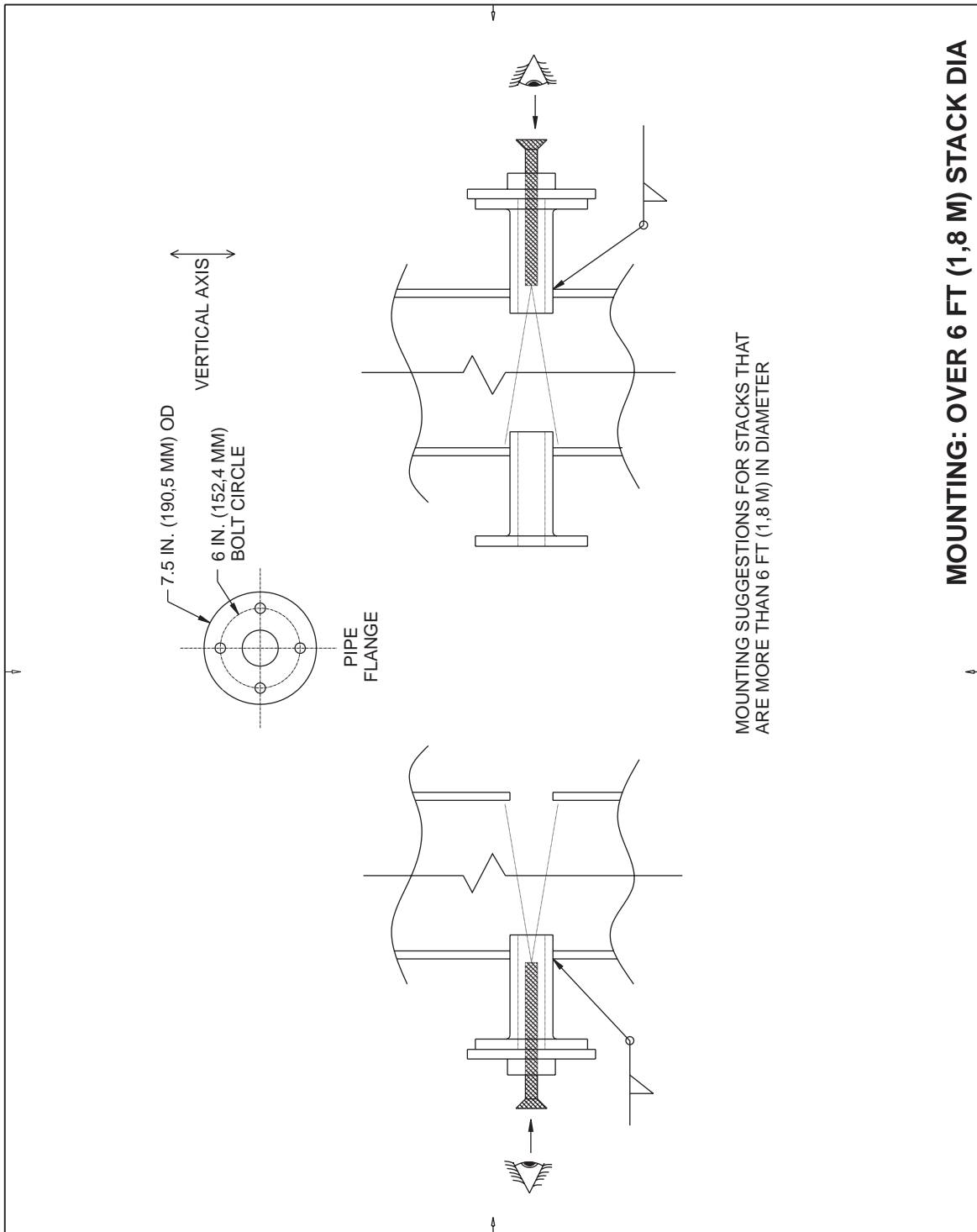
Mounting: Under 6 ft (1,8 m) Diameter .....	page 10-2
Mounting: Over 6 ft (1,8 m) Diameter .....	page 10-3
Air Purge/Weather Cover Mechanical Installation .....	page 10-4
Panel Cutout for Control Unit .....	page 10-5
Control Unit Dimensions .....	page 10-6
Control Unit Terminal Identification .....	page 10-7
Typical System Wiring (Sheet 1 of 2) .....	page 10-8
Typical System Wiring (Sheet 2 of 2) .....	page 10-9
Transceiver and Retro Reflector Signal and Control Wiring .	page 10-10

---

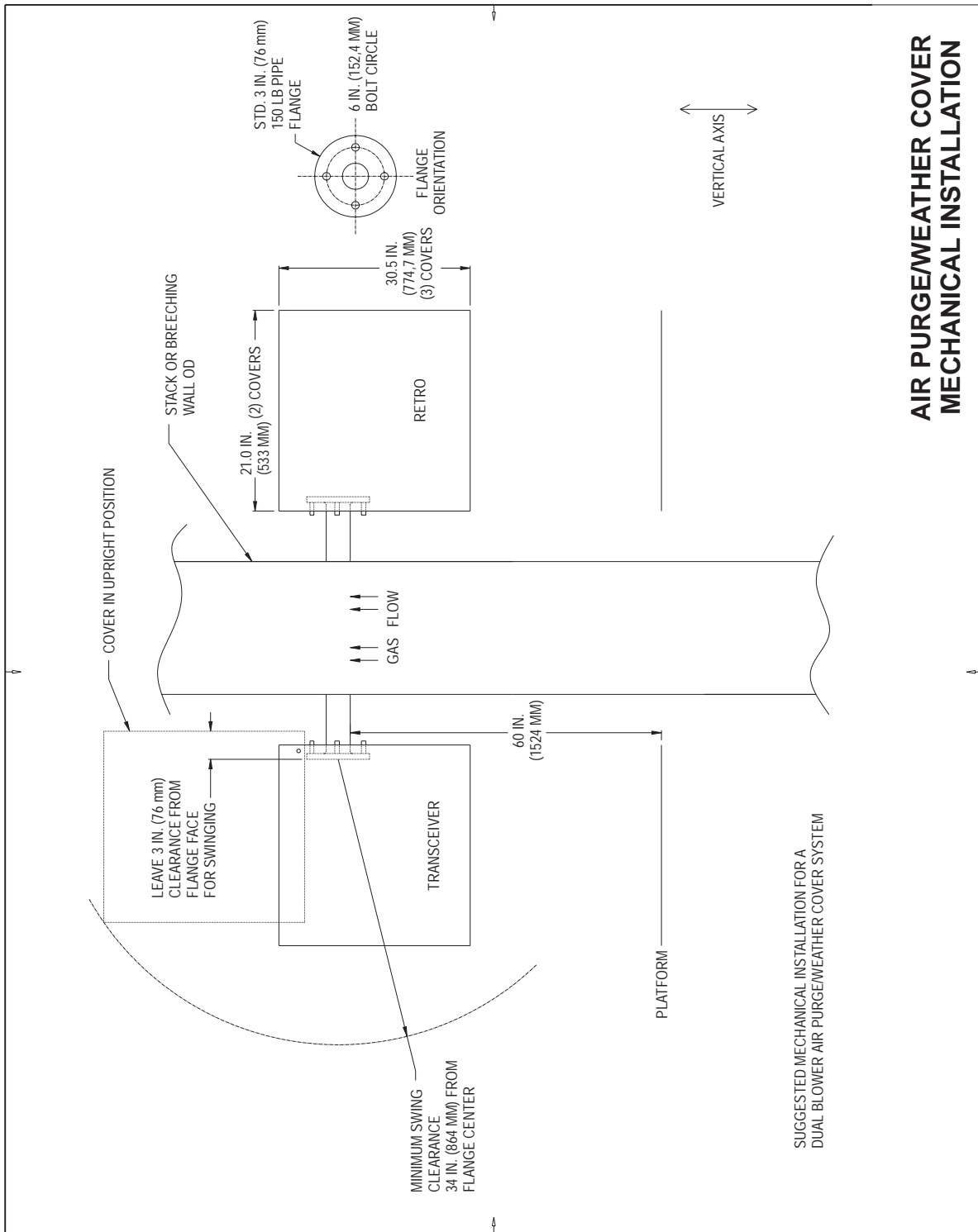
**MOUNTING: UNDER 6 FT (1,8 M) DIAMETER**



**MOUNTING: OVER 6 FT (1,8 M) DIAMETER**

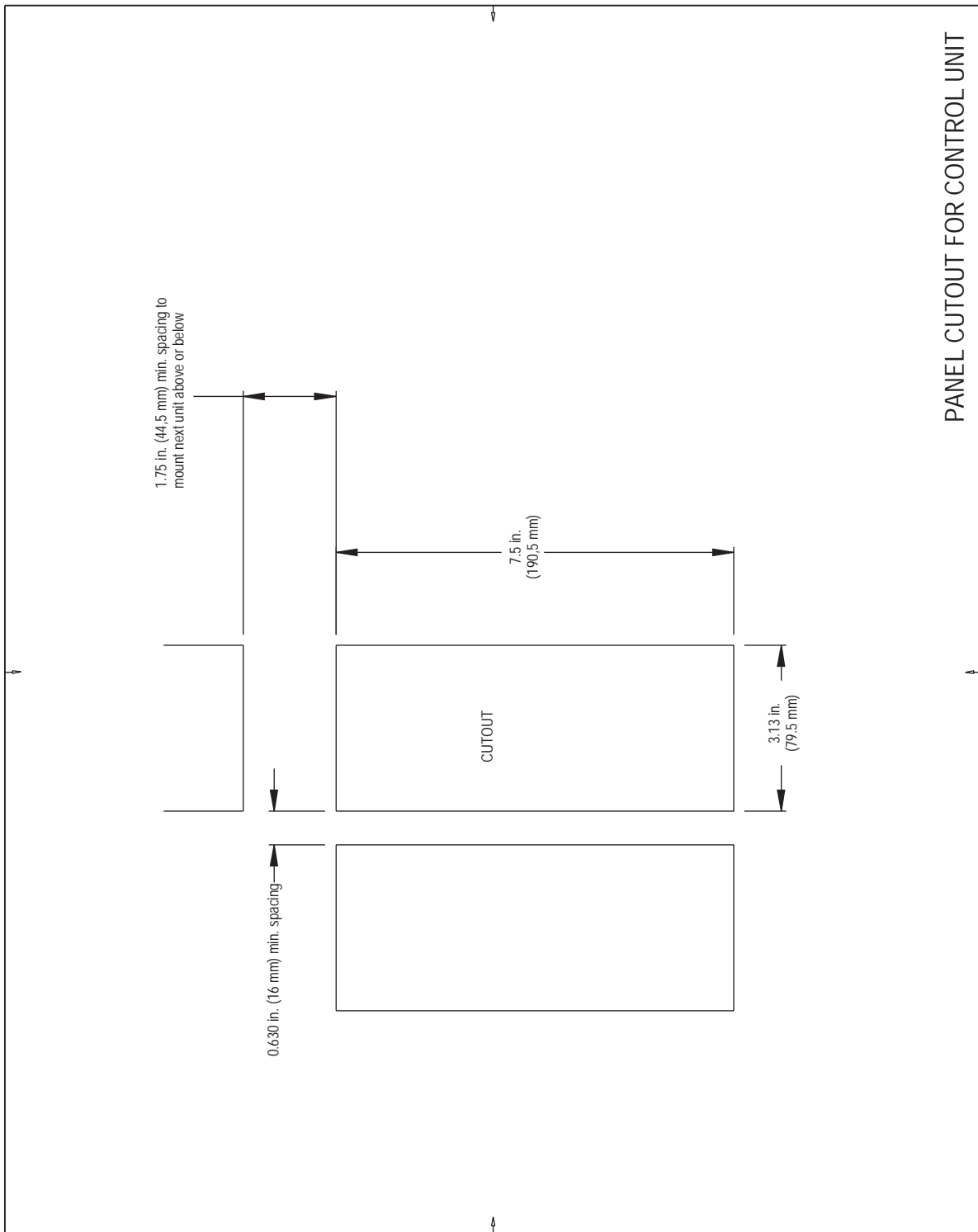


**AIR PURGE/WEATHER COVER MECHANICAL INSTALLATION**

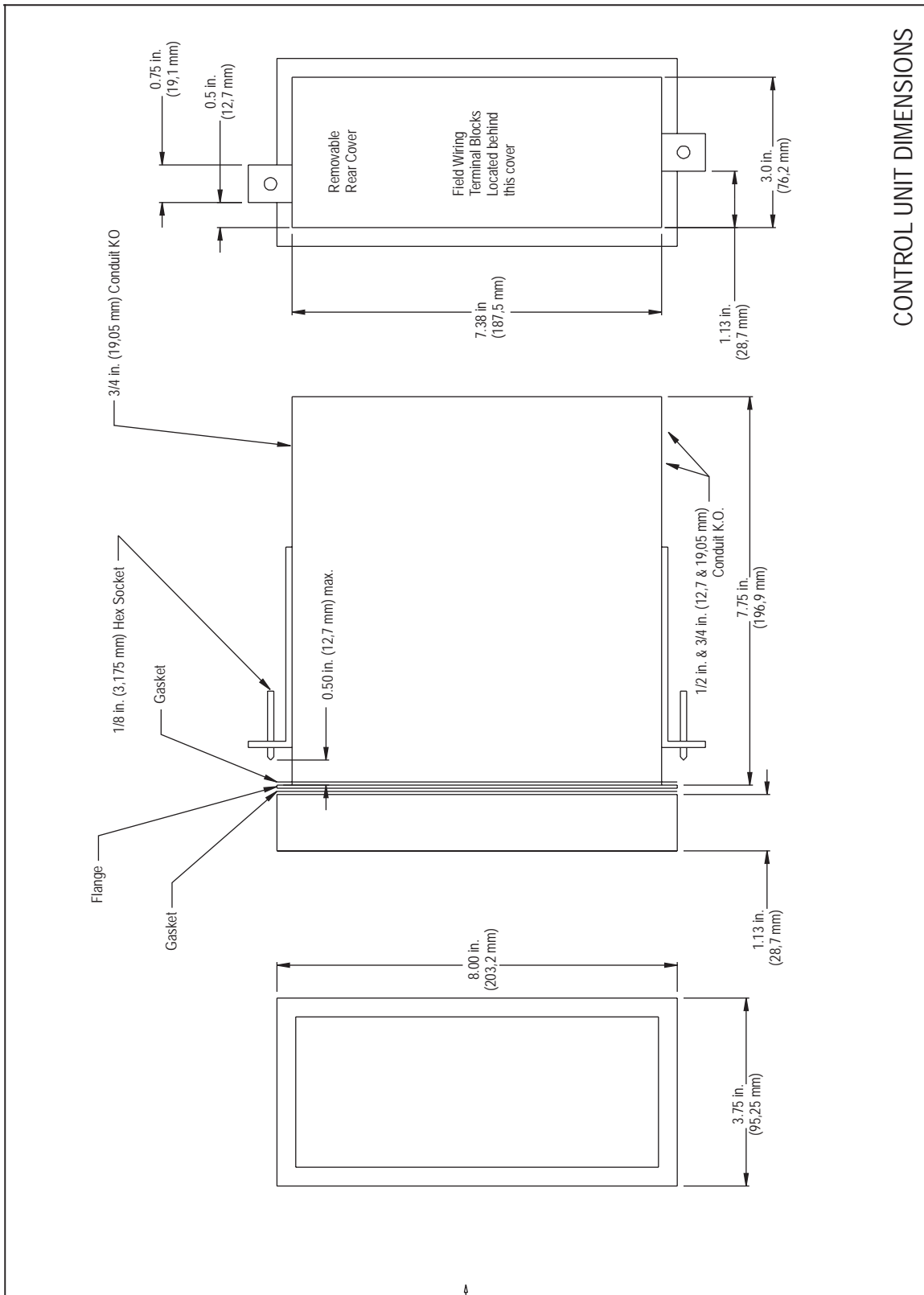




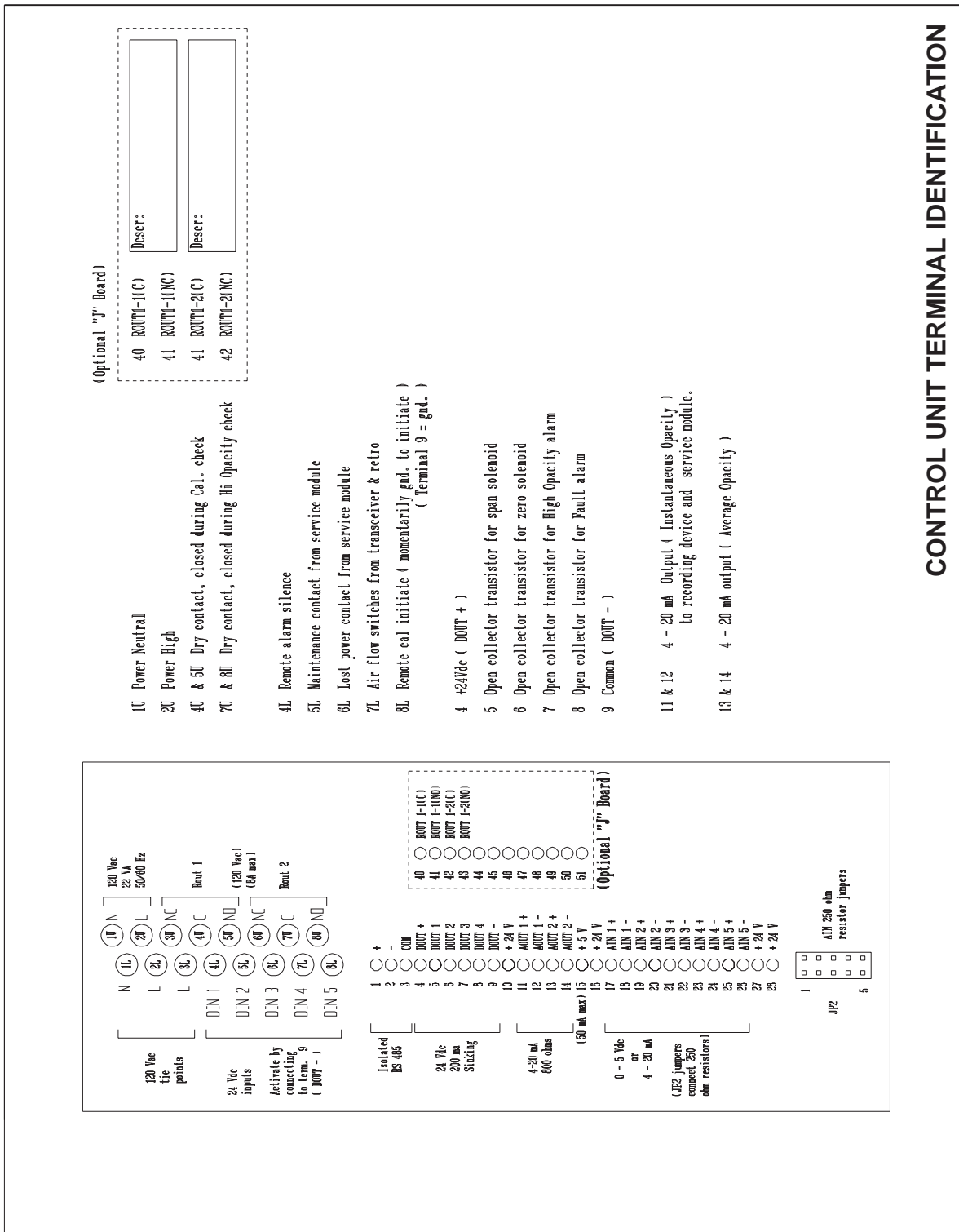
**PANEL CUTOUT FOR CONTROL UNIT**



CONTROL UNIT DIMENSIONS



**CONTROL UNIT TERMINAL IDENTIFICATION**



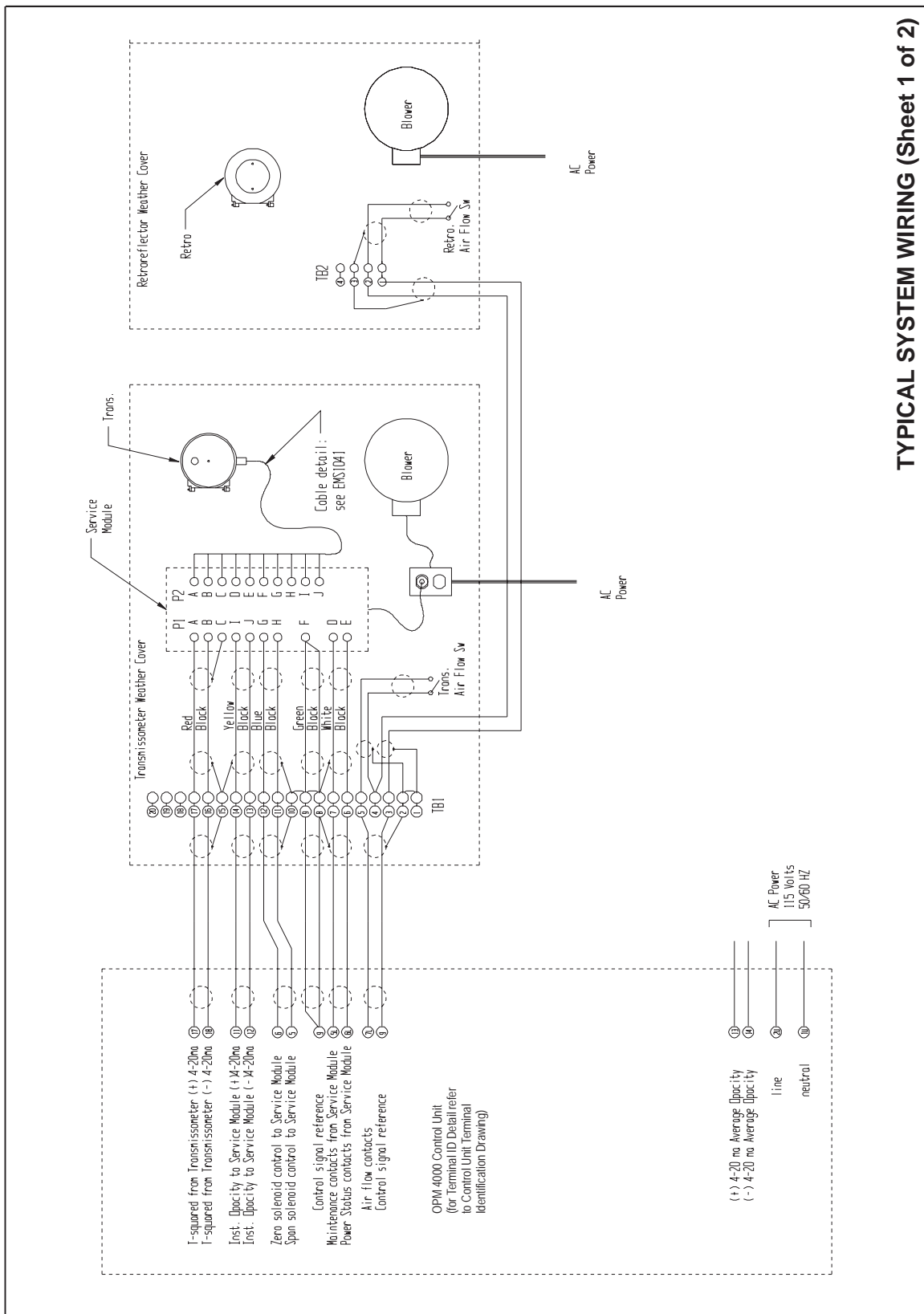
- 10 Power Neutral
- 20 Power High
- 40 & 50 Dry contact, closed during Cal. check
- 70 & 80 Dry contact, closed during Hi Opacity check

- 4L Remote alarm silence
- 5L Maintenance contact from service module
- 6L Lost power contact from service module
- 7L Air flow switches from transceiver & retro
- 8L Remote cal initiate ( momentarily gnd. to initiate ) ( Terminal 9 = gnd. )
- 4 +24Vdc ( DOOT + )
- 5 Open collector transistor for span solenoid
- 6 Open collector transistor for zero solenoid
- 7 Open collector transistor for High Opacity alarm
- 8 Open collector transistor for Fault alarm
- 9 Common ( DOOT - )

- 11 & 12 4 - 20 mA Output ( Instantaneous Opacity ) to recording device and service module.
- 13 & 14 4 - 20 mA output ( Average Opacity )

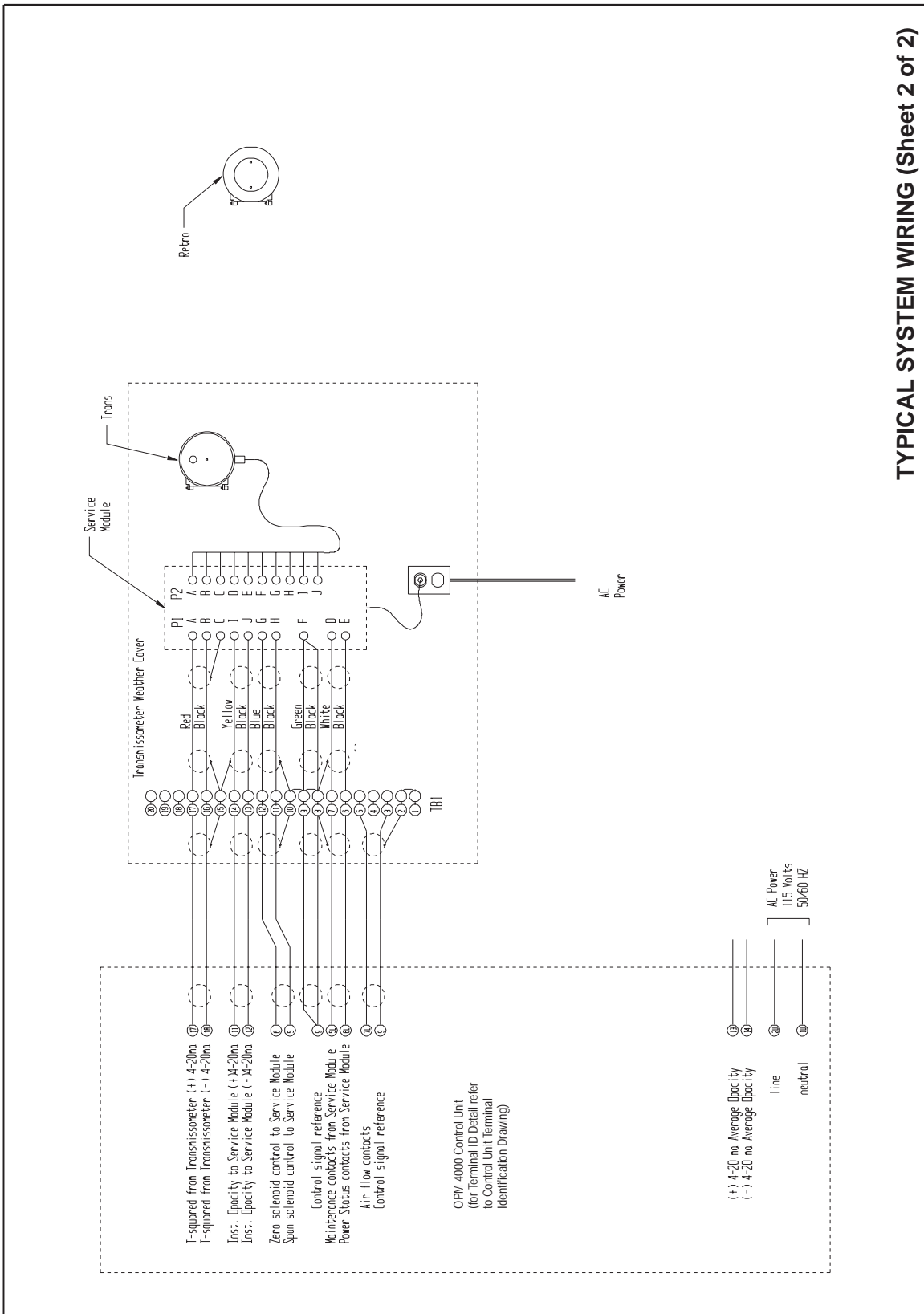
**CONTROL UNIT TERMINAL IDENTIFICATION**

## TYPICAL SYSTEM WIRING (SHEET 1 OF 2)



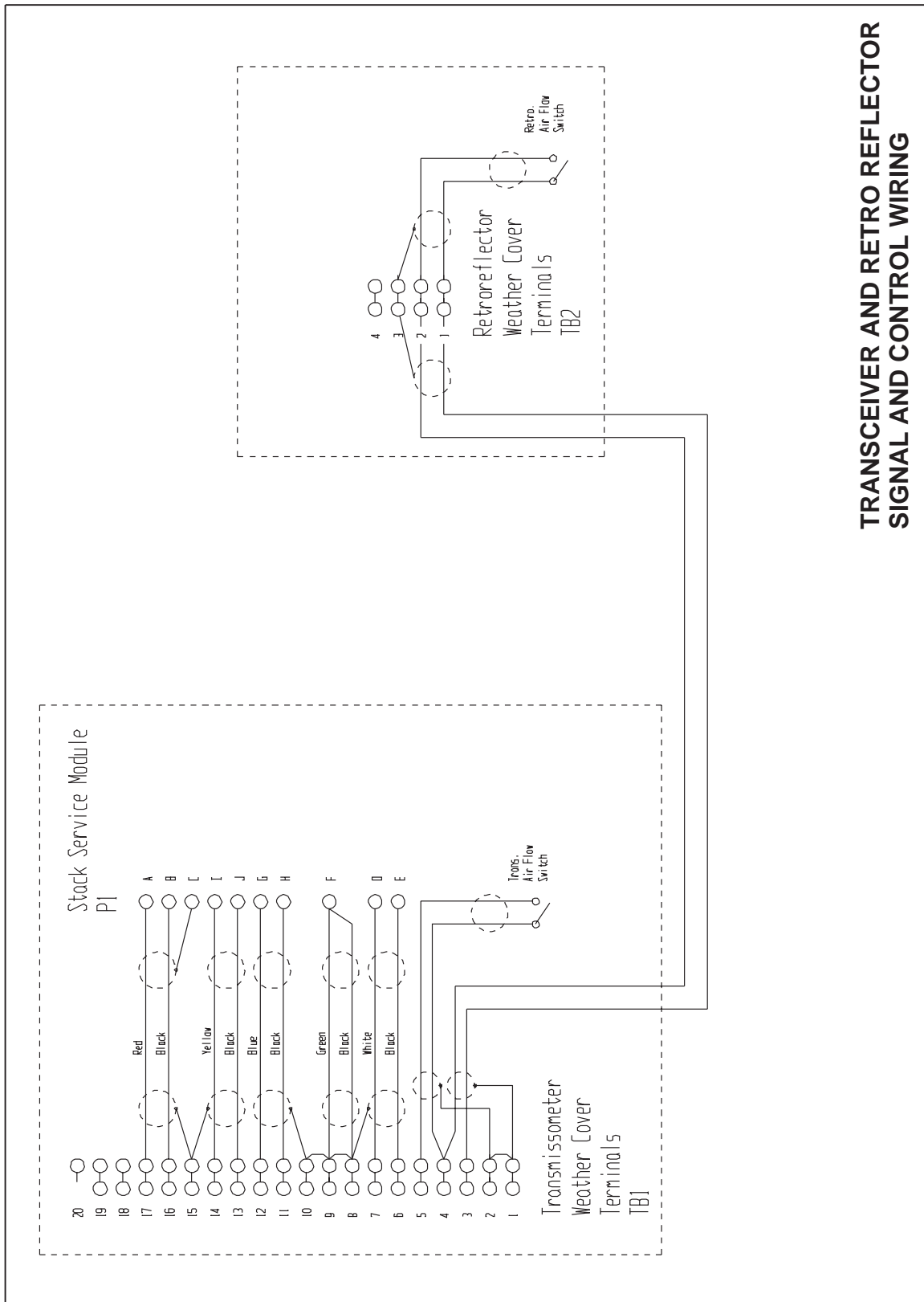
TYPICAL SYSTEM WIRING (Sheet 1 of 2)

**TYPICAL SYSTEM WIRING (SHEET 2 OF 2)**



**TYPICAL SYSTEM WIRING (Sheet 2 of 2)**

TRANSCIEVER AND RETRO REFLECTOR SIGNAL AND CONTROL WIRING



TRANSCIEVER AND RETRO REFLECTOR  
 SIGNAL AND CONTROL WIRING

---

# Appendix A      Safety Data

---

Safety Instructions .....	page A-2
---------------------------	----------




---

**SAFETY INSTRUCTIONS**

**IMPORTANT**

**SAFETY INSTRUCTIONS FOR THE WIRING AND INSTALLATION OF THIS APPARATUS**

The following safety instructions apply specifically to all EU member states. They should be strictly adhered to in order to assure compliance with the Low Voltage Directive. Non-EU states should also comply with the following unless superseded by local or National Standards.




1. Adequate earth connections should be made to all earthing points, internal and external, where provided.
2. After installation or troubleshooting, all safety covers and safety grounds must be replaced. The integrity of all earth terminals must be maintained at all times.
3. Mains supply cords should comply with the requirements of IEC227 or IEC245.
4. All wiring shall be suitable for use in an ambient temperature of greater than 75°C.
5. All cable glands used should be of such internal dimensions as to provide adequate cable anchorage.
6. To ensure safe operation of this equipment, connection to the mains supply should only be made through a circuit breaker which will disconnect all circuits carrying conductors during a fault situation. The circuit breaker may also include a mechanically operated isolating switch. If not, then another means of disconnecting the equipment from the supply must be provided and clearly marked as such. Circuit breakers or switches must comply with a recognized standard such as IEC947. All wiring must conform with any local standards.
7. Where equipment or covers are marked with the symbol to the right, hazardous voltages are likely to be present beneath. These covers should only be removed when power is removed from the equipment - and then only by trained service personnel. 
8. Where equipment or covers are marked with the symbol to the right, there is a danger from hot surfaces beneath. These covers should only be removed by trained service personnel when power is removed from the equipment. Certain surfaces may remain hot to the touch. 
9. Where equipment or covers are marked with the symbol to the right, refer to the Operator Manual for instructions. 
10. All graphical symbols used in this product are from one or more of the following standards: EN61010-1, IEC417, and ISO3864.



## **BELANGRIJK**

**Veiligheidsvoorschriften voor de aansluiting en installatie van dit toestel.**

**De hierna volgende veiligheidsvoorschriften zijn vooral bedoeld voor de EU lidstaten. Hier moet aan gehouden worden om de onderworpenheid aan de Laag Spannings Richtlijn (Low Voltage Directive) te verzekeren. Niet EU staten zouden deze richtlijnen moeten volgen tenzij zij reeds achterhaald zouden zijn door plaatselijke of nationale voorschriften.**

1. Degelijke aardingsaansluitingen moeten gemaakt worden naar alle voorziene aardpunten, intern en extern.
2. Na installatie of controle moeten alle veiligheidsdeksels en -aarding terug geplaatst worden. Ten alle tijde moet de betrouwbaarheid van de aarding behouden blijven.
3. Voedingskabels moeten onderworpen zijn aan de IEC227 of de IEC245 voorschriften.
4. Alle bekabeling moet geschikt zijn voor het gebruik in omgevingstemperaturen, hoger dan 75°C.
5. Alle wartels moeten zo gedimensioneerd zijn dat een degelijke kabel bevestiging verzekerd is.
6. Om de veilige werking van dit toestel te verzekeren, moet de voeding door een stroomonderbreker gevoerd worden (min 10A) welke alle draden van de voeding moet onderbreken. De stroomonderbreker mag een mechanische schakelaar bevatten. Zoniet moet een andere mogelijkheid bestaan om de voedingsspanning van het toestel te halen en ook duidelijk zo zijn aangegeven. Stroomonderbrekers of schakelaars moeten onderworpen zijn aan een erkende standaard zoals IEC947.
7. Waar toestellen of deksels aangegeven staan met het symbool is er meestal hoogspanning aanwezig. Deze deksels mogen enkel verwijderd worden nadat de voedingsspanning werd afgelegd en enkel door getraind onderhoudspersoneel. 
8. Waar toestellen of deksels aangegeven staan met het symbool is er gevaar voor hete oppervlakken. Deze deksels mogen enkel verwijderd worden door getraind onderhoudspersoneel nadat de voedingsspanning verwijderd werd. Sommige oppervlakken kunnen 45 minuten later nog steeds heet aanvoelen. 
9. Waar toestellen of deksels aangegeven staan met het symbool gelieve het handboek te raadplegen. 
10. Alle grafische symbolen gebruikt in dit produkt, zijn afkomstig uit een of meer van de volgende standards: EN61010-1, IEC417 en ISO3864.

## **VIGTIGT**

**Sikkerhedsinstruktion for tilslutning og installation af dette udstyr.**

**Følgende sikkerhedsinstruktioner gælder specifikt i alle EU-medlemslande. Instruktionerne skal nøje følges for overholdelse af Lavspændingsdirektivet og bør også følges i ikke EU-lande medmindre andet er specificeret af lokale eller nationale standarder.**

1. Passende jordforbindelser skal tilsluttes alle jordklemmer, interne og eksterne, hvor disse forefindes.
2. Efter installation eller fejlfinding skal alle sikkerhedsdæksler og jordforbindelser reetableres.
3. Forsyningskabler skal opfylde krav specificeret i IEC227 eller IEC245.
4. Alle ledningstilslutninger skal være konstrueret til omgivelsestemperatur højere end 75°C.
5. Alle benyttede kabelforskrutninger skal have en intern dimension, så passende kabelafastning kan etableres.
6. For opnåelse af sikker drift og betjening skal der skabes beskyttelse mod indirekte berøring gennem afbryder (min. 10A), som vil afbryde alle kredsløb med elektriske ledere i fejlsituation. Afbryderen skal indholde en mekanisk betjent kontakt. Hvis ikke skal anden form for afbryder mellem forsyning og udstyr benyttes og mærkes som sådan. Afbrydere eller kontakter skal overholde en kendt standard som IEC947.
7. Hvor udstyr eller dæksler er mærket med dette symbol, er farlige spændinger normalt forekommende bagved. Disse dæksler bør kun afmonteres, når forsyningsspændingen er frakoblet - og da kun af instrueret servicepersonale. 
8. Hvor udstyr eller dæksler er mærket med dette symbol, forefindes meget varme overflader bagved. Disse dæksler bør kun afmonteres af instrueret servicepersonale, når forsyningsspænding er frakoblet. Visse overflader vil stadig være for varme at berøre i op til 45 minutter efter frakobling. 
9. Hvor udstyr eller dæksler er mærket med dette symbol, se da i betjeningsmanual for instruktion. 
10. Alle benyttede grafiske symboler i dette udstyr findes i én eller flere af følgende standarder:- EN61010-1, IEC417 & ISO3864.

## **BELANGRIJK**

**Veiligheidsinstructies voor de bedrading en installatie van dit apparaat.**

**Voor alle EU lidstaten zijn de volgende veiligheidsinstructies van toepassing. Om aan de geldende richtlijnen voor laagspanning te voldoen dient men zich hieraan strikt te houden. Ook niet EU lidstaten dienen zich aan het volgende te houden, tenzij de lokale wetgeving anders voorschrijft.**



1. Alle voorziene interne- en externe aardaansluitingen dienen op adequate wijze aangesloten te worden.
2. Na installatie, onderhouds- of reparatie werkzaamheden dienen alle beschermdeksels /kappen en aardingen om reden van veiligheid weer aangebracht te worden.
3. Voedingskabels dienen te voldoen aan de vereisten van de normen IEC 227 of IEC 245.
4. Alle bedrading dient geschikt te zijn voor gebruik bij een omgevings temperatuur boven 75°C.
5. Alle gebruikte kabelwartels dienen dusdanige inwendige afmetingen te hebben dat een adequate verankering van de kabel wordt verkregen.
6. Om een veilige werking van de apparatuur te waarborgen dient de voeding uitsluitend plaats te vinden via een meerpolige automatische zekering (min.10A) die alle spanningvoerende geleiders verbreekt indien een foutconditie optreedt. Deze automatische zekering mag ook voorzien zijn van een mechanisch bediende schakelaar. Bij het ontbreken van deze voorziening dient een andere als zodanig duidelijk aangegeven mogelijkheid aanwezig te zijn om de spanning van de apparatuur af te schakelen. Zekeringen en schakelaars dienen te voldoen aan een erkende standaard zoals IEC 947.
7. Waar de apparatuur of de beschermdeksels/kappen gemarkeerd zijn met het volgende symbool, kunnen zich hieronder spanning voerende delen bevinden die gevaar op kunnen leveren. Deze beschermdeksels/ kappen mogen uitsluitend verwijderd worden door getraind personeel als de spanning is afgeschakeld.
8. Waar de apparatuur of de beschermdeksels/kappen gemarkeerd zijn met het volgende symbool, kunnen zich hieronder hete oppervlakken of onderdelen bevinden. Bepaalde delen kunnen mogelijk na 45 min. nog te heet zijn om aan te raken.
9. Waar de apparatuur of de beschermdeksels/kappen gemarkeerd zijn met het volgende symbool, dient men de bedieningshandleiding te raadplegen.
10. Alle grafische symbolen gebruikt bij dit produkt zijn volgens een of meer van de volgende standaarden: EN 61010-1, IEC 417 & ISO 3864.



## TÄRKEÄÄ

**Turvallisuusohje, jota on noudatettava tämän laitteen asentamisessa ja kaapeloinnissa.**

**Seuraavat ohjeet pätevät erityisesti EU:n jäsenvaltioissa. Niitä täytyy ehdottomasti noudattaa jotta täytettäisiin EU:n matalajännittdirektiivin (Low Voltage Directive) yhteensopivuus. Myös EU:hun kuulumattomien valtioiden tulee noudattaa tätä ohjetta, elleivät kansalliset standardit estä sitä.**

1. Riittävät maadoituskytkennät on tehtävä kaikkiin maadoituspisteisiin, sisäisiin ja ulkoisiin.
2. Asennuksen ja vianetsinnän jälkeen on kaikki suojat ja suojamaat asennettava takaisin paikoilleen. Maadoitusliittimen kunnollinen toiminta täytyy aina ylläpitää.
3. Jännitesyöttöjohtimien täytyy täyttää IEC227 ja IEC245 vaatimukset.
4. Kaikkien johdotuksien tulee toimia >75°C lämpötiloissa.
5. Kaikkien läpivientiholkkien sisähalkaisijan täytyy olla sellainen että kaapeli lukkiutuu kun-nolla kiinni.
6. Turvallisen toiminnan varmistamiseksi täytyy jännitesyöttö varustaa turvakytkimellä (min 10A), joka kytkee irti kaikki jännitesyöttöjohtimet vikatilanteessa. Suojaan täytyy myös sisältyä mekaaninen erotuskytkin. Jos ei, niin jännitesyöttö on pystyttävä katkaisemaan muilla keinoilla ja merkittävä siten että se tunnustetaan sellaiseksi. Turvakytkimien tai katkaisimien täytyy täyttää IEC947 standardin vaatimukset näkyvyydestä.
7. Mikäli laite tai kosketussuoja on merkitty tällä merkillä on merkinnän takana tai alla hengenvaarallisen suuruinen jännite. Suojaa ei saa poistaa jänniteen ollessa kytkettynä laitteeseen ja poistamisen saa suorittaa vain alan asian-tuntija. 
8. Mikäli laite tai kosketussuoja on merkitty tällä merkillä on merkinnän takana tai alla kuuma pinta. Suojan saa poistaa vain alan asiantuntija kun jännite-syöttö on katkaistu. Tällainen pinta voi säilyä kosketuskuumana jopa 45 mi-nuuttia. 
9. Mikäli laite tai kosketussuoja on merkitty tällä merkillä katso lisäohjeita käyt-töohjekirjasta. 
10. Kaikki tässä tuotteessa käytetyt graafiset symbolit ovat yhdestä tai useammasta seuraavista standardeista: EN61010-1, IEC417 & ISO3864.

## **IMPORTANT**

**Consignes de sécurité concernant le raccordement et l'installation de cet appareil.**

**Les consignes de sécurité ci-dessous s'adressent particulièrement à tous les états membres de la communauté européenne. Elles doivent être strictement appliquées afin de satisfaire aux directives concernant la basse tension. Les états non membres de la communauté européenne doivent également appliquer ces consignes sauf si elles sont en contradiction avec les standards locaux ou nationaux.**

1. Un raccordement adéquat à la terre doit être effectuée à chaque borne de mise à la terre, interne et externe.
2. Après installation ou dépannage, tous les capots de protection et toutes les prises de terre doivent être remis en place, toutes les prises de terre doivent être respectées en permanence.
3. Les câbles d'alimentation électrique doivent être conformes aux normes IEC227 ou IEC245.
4. Tous les raccordements doivent pouvoir supporter une température ambiante supérieure à 75°C.
5. Tous les presse-étoupes utilisés doivent avoir un diamètre interne en rapport avec les câbles afin d'assurer un serrage correct sur ces derniers.
6. Afin de garantir la sécurité du fonctionnement de cet appareil, le raccordement à l'alimentation électrique doit être réalisé exclusivement au travers d'un disjoncteur (minimum 10A.) isolant tous les conducteurs en cas d'anomalie. Ce disjoncteur doit également pouvoir être actionné manuellement, de façon mécanique. Dans le cas contraire, un autre système doit être mis en place afin de pouvoir isoler l'appareil et doit être signalisé comme tel. Disjoncteurs et interrupteurs doivent être conformes à une norme reconnue telle IEC947.
7. Lorsque les équipements ou les capots affichent le symbole suivant, cela signifie que des tensions dangereuses sont présentes. Ces capots ne doivent être démontés que lorsque l'alimentation est coupée, et uniquement par un personnel compétent.
8. Lorsque les équipements ou les capots affichent le symbole suivant, cela signifie que des surfaces dangereusement chaudes sont présentes. Ces capots ne doivent être démontés que lorsque l'alimentation est coupée, et uniquement par un personnel compétent. Certaines surfaces peuvent rester chaudes jusqu'à 45 mn.
9. Lorsque les équipements ou les capots affichent le symbole suivant, se reporter au manuel d'instructions.
10. Tous les symboles graphiques utilisés dans ce produit sont conformes à un ou plusieurs des standards suivants: EN61010-1, IEC417 & ISO3864.



## WICHTIG

### **Sicherheitshinweise für den Anschluß und die Installation dieser Geräte.**

**Die folgenden Sicherheitshinweise sind in allen Mitgliederstaaten der europäischen Gemeinschaft gültig. Sie müssen strikt eingehalten werden, um der Niederspannungsrichtlinie zu genügen. Nichtmitgliedstaaten der europäischen Gemeinschaft sollten die national gültigen Normen und Richtlinien einhalten.**

1. Alle intern und extern vorgesehene Erdungen der Geräte müssen ausgeführt werden.
2. Nach Installation, Reparatur oder sonstigen Eingriffen in das Gerät müssen alle Sicherheitsabdeckungen und Erdungen wieder installiert werden. Die Funktion aller Erdverbindungen darf zu keinem Zeitpunkt gestört sein.
3. Die Netzspannungsversorgung muß den Anforderungen der IEC227 oder IEC245 genügen.
4. Alle Verdrahtungen sollten mindestens bis 75°C ihre Funktion dauerhaft erfüllen.
5. Alle Kabeldurchführungen und Kabelverschraubungen sollten in Ihrer Dimensionierung so gewählt werden, daß diese eine sichere Verkabelung des Gerätes ermöglichen.
6. Um eine sichere Funktion des Gerätes zu gewährleisten, muß die Spannungsversorgung über mindestens 10 A abgesichert sein. Im Fehlerfall muß dadurch gewährleistet sein, daß die Spannungsversorgung zum Gerät bzw. zu den Geräten unterbrochen wird. Ein mechanischer Schutzschalter kann in dieses System integriert werden. Falls eine derartige Vorrichtung nicht vorhanden ist, muß eine andere Möglichkeit zur Unterbrechung der Spannungszufuhr gewährleistet werden mit Hinweisen deutlich gekennzeichnet werden. Ein solcher Mechanismus zur Spannungsunterbrechung muß mit den Normen und Richtlinien für die allgemeine Installation von Elektrogeräten, wie zum Beispiel der IEC947, übereinstimmen.



7. Mit dem Symbol sind Geräte oder Abdeckungen gekennzeichnet, die eine gefährliche (Netzspannung) Spannung führen. Die Abdeckungen dürfen nur entfernt werden, wenn die Versorgungsspannung unterbrochen wurde. Nur geschultes Personal darf an diesen Geräten Arbeiten ausführen.



8. Mit dem Symbol sind Geräte oder Abdeckungen gekennzeichnet, in bzw. unter denen heiße Teile vorhanden sind. Die Abdeckungen dürfen nur entfernt werden, wenn die Versorgungsspannung unterbrochen wurde. Nur geschultes Personal darf an diesen Geräten Arbeiten ausführen. Bis 45 Minuten nach dem Unterbrechen der Netzzufuhr können derartige Teile noch über eine erhöhte Temperatur verfügen.






9. Mit dem Symbol sind Geräte oder Abdeckungen gekennzeichnet, bei denen vor dem Eingriff die entsprechenden Kapitel im Handbuch sorgfältig durchgelesen werden müssen.
10. Alle in diesem Gerät verwendeten graphischen Symbole entspringen einem oder mehreren der nachfolgend aufgeführten Standards: EN61010-1, IEC417 & ISO3864.

## **IMPORTANTE**

**Norme di sicurezza per il cablaggio e l'installazione dello strumento.**




**Le seguenti norme di sicurezza si applicano specificatamente agli stati membri dell'Unione Europea, la cui stretta osservanza è richiesta per garantire conformità alla Direttiva del Basso Voltaggio. Esse si applicano anche agli stati non appartenenti all'Unione Europea, salvo quanto disposto dalle vigenti normative locali o nazionali.**

1. Collegamenti di terra idonei devono essere eseguiti per tutti i punti di messa a terra interni ed esterni, dove previsti.
2. Dopo l'installazione o la localizzazione dei guasti, assicurarsi che tutti i coperchi di protezione siano stati collocati e le messa a terra siano collegate. L'integrità di ciascun morsetto di terra deve essere costantemente garantita.
3. I cavi di alimentazione della rete devono essere secondo disposizioni IEC227 o IEC245.
4. L'intero impianto elettrico deve essere adatto per uso in ambiente con temperature superiore a 75°C.
5. Le dimensioni di tutti i connettori dei cavi utilizzati devono essere tali da consentire un adeguato ancoraggio al cavo.
6. Per garantire un sicuro funzionamento dello strumento il collegamento alla rete di alimentazione principale dovrà essere eseguita tramite interruttore automatico (min.10A), in grado di disattivare tutti i conduttori di circuito in caso di guasto. Tale interruttore dovrà inoltre prevedere un sezionatore manuale o altro dispositivo di interruzione dell'alimentazione, chiaramente identificabile. Gli interruttori dovranno essere conformi agli standard riconosciuti, quali IEC947.
7. Il simbolo riportato sullo strumento o sui coperchi di protezione indica probabile presenza di elevati voltaggi. Tali coperchi di protezione devono essere rimossi esclusivamente da personale qualificato, dopo aver tolto alimentazione allo strumento. 
8. Il simbolo riportato sullo strumento o sui coperchi di protezione indica rischio di contatto con superfici ad alta temperatura. Tali coperchi di protezione devono essere rimossi esclusivamente da personale qualificato, dopo aver tolto alimentazione allo strumento. Alcune superfici possono mantenere temperature elevate per oltre 45 minuti. 
9. Se lo strumento o il coperchio di protezione riportano il simbolo, fare riferimento alle istruzioni del manuale Operatore. 
10. Tutti i simboli grafici utilizzati in questo prodotto sono previsti da uno o più dei seguenti standard: EN61010-1, IEC417 e ISO3864.

## **VIKTIG**

### **Sikkerhetsinstruks for tilkobling og installasjon av dette utstyret.**

**Følgende sikkerhetsinstruksjoner gjelder spesifikt alle EU medlemsland og land med i EØS-avtalen. Instruksjonene skal følges nøye slik at installasjonen blir i henhold til lavspenningsdirektivet. Den bør også følges i andre land, med mindre annet er spesifisert av lokale- eller nasjonale standarder.**




1. Passende jordforbindelser må tilkobles alle jordingspunkter, interne og eksterne hvor disse forefinnes.
2. Etter installasjon eller feilsøking skal alle sikkerhetsdeksler og jordforbindelser reetableres. Jordingsforbindelsene må alltid holdes i god stand.
3. Kabler fra spenningsforsyning skal oppfylle kravene spesifisert i IEC227 eller IEC245.
4. Alle ledningsforbindelser skal være konstruert for en omgivelsestemperatur høyere en 750°C.
5. Alle kabelforskrivninger som benyttes skal ha en indre dimensjon slik at tilstrekkelig avlastning oppnåes.
6. For å oppnå sikker drift og betjening skal forbindelsen til spenningsforsyningen bare skje gjennom en strømbryter (minimum 10A) som vil bryte spenningsforsyningen til alle elektriske kretser ved en feilsituasjon. Strømbryteren kan også inneholde en mekanisk operert bryter for å isolere instrumentet fra spenningsforsyningen. Dersom det ikke er en mekanisk operert bryter installert, må det være en annen måte å isolere utstyret fra spenningsforsyningen, og denne måten må være tydelig merket. Kretsbytere eller kontakter skal oppfylle kravene i en annerkjent standard av typen IEC947 eller tilsvarende.
7. Der hvor utstyr eller deksler er merket med symbol for farlig spenning, er det sannsynlig at disse er tilstede bak dekslet. Disse dekslene må bare fjernes når spenningsforsyning er frakoblet utstyret, og da bare av trent servicepersonell. 
8. Der hvor utstyr eller deksler er merket med symbol for meget varm overflate, er det sannsynlig at disse er tilstede bak dekslet. Disse dekslene må bare fjernes når spenningsforsyning er frakoblet utstyret, og da bare av trent servicepersonell. Noen overflater kan være for varme til å berøres i opp til 45 minutter etter spenningsforsyning frakoblet. 
9. Der hvor utstyret eller deksler er merket med symbol, vennligst referer til instruksjonsmanualen for instruksjer. 
10. Alle grafiske symboler brukt i dette produktet er fra en eller flere av følgende standarder: EN61010-1, IEC417 & ISO3864.



## **IMPORTANTE**

**Instruções de segurança para ligação e instalação deste aparelho.**

**As seguintes instruções de segurança aplicam-se especificamente a todos os estados membros da UE. Devem ser observadas rigidamente por forma a garantir o cumprimento da Directiva sobre Baixa Tensão. Relativamente aos estados que não pertençam à UE, deverão cumprir igualmente a referida directiva, exceptuando os casos em que a legislação local a tiver substituído.**

1. Devem ser feitas ligações de terra apropriadas a todos os pontos de terra, internos ou externos.
2. Após a instalação ou eventual reparação, devem ser recolocadas todas as tampas de segurança e terras de protecção. Deve manter-se sempre a integridade de todos os terminais de terra.
3. Os cabos de alimentação eléctrica devem obedecer às exigências das normas IEC227 ou IEC245.
4. Os cabos e fios utilizados nas ligações eléctricas devem ser adequados para utilização a uma temperatura ambiente até 75°C.
5. As dimensões internas dos buçins dos cabos devem ser adequadas a uma boa fixação dos cabos.
6. Para assegurar um funcionamento seguro deste equipamento, a ligação ao cabo de alimentação eléctrica deve ser feita através de um disjuntor (min. 10A) que desligará todos os condutores de circuitos durante uma avaria. O disjuntor poderá também conter um interruptor de isolamento accionado manualmente. Caso contrário, deverá ser instalado qualquer outro meio para desligar o equipamento da energia eléctrica, devendo ser assinalado convenientemente. Os disjuntores ou interruptores devem obedecer a uma norma reconhecida, tipo IEC947.
7. Sempre que o equipamento ou as tampas contiverem o símbolo, é provável a existência de tensões perigosas. Estas tampas só devem ser retiradas quando a energia eléctrica tiver sido desligada e por Pessoal da Assistência devidamente treinado. 
8. Sempre que o equipamento ou as tampas contiverem o símbolo, há perigo de existência de superfícies quentes. Estas tampas só devem ser retiradas por Pessoal da Assistência devidamente treinado e depois de a energia eléctrica ter sido desligada. Algumas superfícies permanecem quentes até 45 minutos depois. 
9. Sempre que o equipamento ou as tampas contiverem o símbolo, o Manual de Funcionamento deve ser consultado para obtenção das necessárias instruções. 
10. Todos os símbolos gráficos utilizados neste produto baseiam-se em uma ou mais das seguintes normas: EN61010-1, IEC417 e ISO3864.

## **IMPORTANTE**

### **Instrucciones de seguridad para el montaje y cableado de este aparato.**

**Las siguientes instrucciones de seguridad, son de aplicacion especifica a todos los miembros de la UE y se adjuntaran para cumplir la normativa europea de baja tension.**




1. Se deben preveer conexiones a tierra del equipo, tanto externa como internamente, en aquellos terminales previstos al efecto.
2. Una vez finalizada las operaciones de mantenimiento del equipo, se deben volver a colocar las cubiertas de seguridad aasi como los terminales de tierra. Se debe comprobar la integridad de cada terminal.
3. Los cables de alimentacion electrica cumplan con las normas IEC 227 o IEC 245.
4. Todo el cableado sera adecuado para una temperatura ambiental de 75°C.
5. Todos los prensaestopas seran adecuados para una fijacion adecuada de los cables.
6. Para un manejo seguro del equipo, la alimentacion electrica se realizara a traves de un interruptor magnetotermico ( min 10 A ), el cual desconectara la alimentacion electrica al equipo en todas sus fases durante un fallo. Los interruptores estaran de acuerdo a la norma IEC 947 u otra de reconocido prestigio.
7. Cuando las tapas o el equipo lleve impreso el simbolo de tension electrica peligrosa, dicho alojamiento solamente se abra una vez que se haya interrumpido la alimentacion electrica al equipo asimismo la intervencion sera llevada a cabo por personal entrenado para estas labores.
8. Cuando las tapas o el equipo lleve impreso el simbolo, hay superficies con alta temperatura, por tanto se abra una vez que se haya interrumpido la alimentacion electrica al equipo por personal entrenado para estas labores, y al menos se esperara unos 45 minutos para enfriar las superficies calientes.
9. Cuando el equipo o la tapa lleve impreso el simbolo, se consultara el manual de instrucciones.
10. Todos los simbolos graficos usados en esta hoja, estan de acuerdo a las siguientes normas EN61010-1, IEC417 & ISO 3864.



## **VIKTIGT**

**Säkerhetsföreskrifter för kablage och installation av denna apparat.**




**Följande säkerhetsföreskrifter är tillämpliga för samtliga EU-medlemsländer. De skall följas i varje avseende för att överensstämna med Lågspännings direktivet. Icke EU medlemsländer skall också följa nedanstående punkter, såvida de inte övergrips av lokala eller nationella föreskrifter.**

1. Tillämplig jordkontakt skall utföras till alla jordade punkter, såväl internt som externt där så erfordras.
2. Efter installation eller felsökning skall samtliga säkerhetshöljen och säkerhetsjord återplaceras. Samtliga jordterminaler måste hållas obrutna hela tiden.
3. Matningsspänningens kabel måste överensstämna med föreskrifterna i IEC227 eller IEC245.
4. Allt kablage skall vara lämpligt för användning i en omgivningstemperatur högre än 75°C.
5. Alla kabelförskruvningar som används skall ha inre dimensioner som motsvarar adekvat kabelförankring.
6. För att säkerställa säker drift av denna utrustning skall anslutning till huvudströmmen endast göras genom en säkring (min 10A) som skall fränkoppla alla strömförande kretsar när något fel uppstår. Säkringen kan även ha en mekanisk frånskiljare. Om så inte är fallet, måste ett annat förfarande för att frånskilja utrustningen från strömförsörjning tillhandahållas och klart framgå genom markering. Säkring eller omkopplare måste överensstämna med en gällande standard såsom t ex IEC947.
7. Där utrustning eller hölje är markerad med vidstående symbol föreligger risk för livsfarlig spänning i närheten. Dessa höljen får endast avlägsnas när strömmen ej är ansluten till utrustningen - och då endast av utbildad servicepersonal. 
8. När utrustning eller hölje är markerad med vidstående symbol föreligger risk för brännskada vid kontakt med uppvärmd yta. Dessa höljen får endast avlägsnas av utbildad servicepersonal, när strömmen kopplats från utrustningen. Vissa ytor kan vara mycket varma att vidröra även upp till 45 minuter efter avstängning av strömmen. 
9. När utrustning eller hölje markerats med vidstående symbol bör instruktionsmanualen studeras för information. 
10. Samtliga grafiska symboler som förekommer i denna produkt finns angivna i en eller flera av följande föreskrifter:- EN61010-1, IEC417 & ISO3864.

## ΠΡΟΣΟΧΗ

### **Οδηγίες ασφαλείας για την καλωδίωση και εγκατάσταση της συσκευής.**

**Οι ακόλουθες οδηγίες ασφαλείας εφαρμόζονται ειδικά σε όλες τις χώρες μέλη της Ευρωπαϊκής Κοινότητας. Θα πρέπει να ακολουθούνται αυστηρά ώστε να εξασφαλιστεί η συμβατότητα με τις οδηγίες για τη Χαμηλή Τάση. Χώρες που δεν είναι μέλη της Ευρωπαϊκής Κοινότητας θα πρέπει επίσης να ακολουθούν τις οδηγίες εκτός εάν αντικαθίστανται από τα Τοπικά ή Εθνικά Πρότυπα.**

1. Επαρκείς συνδέσεις γείωσης θα πρέπει να γίνονται σε όλα τα σημεία γείωσης, εσωτερικά και εξωτερικά όπου υπάρχουν.
2. Μετά την εγκατάσταση ή την εκοσμημάτωση όλα τα καλύματα ασφαλείας και οι γειώσεις ασφαλείας πρέπει να επανεγκαθίστανται. Η καλή κατάσταση όλων των ακροδεκτών γείωσης πρέπει να ελέγχεται και να συντηρείται διαρκώς.
3. Τα καλώδια τροφοδοσίας πρέπει να πληρούν τις απαιτήσεις των IEC227 ή IEC245.
4. Όλες οι καλωδιώσεις θα πρέπει να είναι κατάλληλες για χρήση σε ατμοσφαιρική θερμοκρασία χώρου υψηλότερη από 75°C.
5. Όλοι οι στυπιοθλίπτες θα πρέπει να είναι τέτοιων εσωτερικών διαστάσεων ώστε να παρέχουν επαρκή στερέωση των καλωδίων.
6. Για τη διασφάλιση ασφαλούς λειτουργίας της σύνδεσης τροφοδοσίας αυτής της συσκευής θα πρέπει να γίνεται μόνο μέσω ασφαλειοδιακόπτη (ελάχιστο 10A) ο οποίος θα αποσυνδέει όλους του ηλεκτροφόρους αγωγούς στη διάρκεια κατάστασης σφάλματος.  
 Ο ασφαλειοδιακόπτης μπορεί επίσης να περιλαμβάνει μηχανικό διακόπτη απομόνωσης. Εάν δεν περιλαμβάνει, τότε άλλα μέσα αποσύνδεσης της συσκευής από την τροφοδοσία πρέπει να παροχρηθούν και σαφώς να σημειθούν σαν τέτοια. Οι ασφαλειοδιακόπτες ή διακόπτες πρέπει να συμφωνούν με αναγνωρισμένα πρότυπα όπως το IEC947.
7. Όπου συσκευές ή καλύματα είναι σημασμένα με το σύμβολο επικίνδυνες τάσεις ενυπάρχουν κάτω από αυτά. Αυτά τα καλύματα θα πρέπει να αφαιρούνται μόνο όταν έχει αφαιρεθεί η τροφοδοσία από τη συσκευή και τότε μόνο από ειδικευμένο τεχνικό προσωπικό. 
8. Όπου συσκευές ή καλύματα είναι σημασμένα με το σύμβολο υπάρχει κίνδυνος από καυτές επιφάνειες κάτω από αυτά. Αυτά τα καλύματα θα πρέπει να αφαιρούνται μόνο από ειδικευμένο τεχνικό προσωπικό, όταν η τροφοδοσία έχει αφαιρεθεί από τη συσκευή. Τέτοιες επιφάνειες μπορούν να παραμείνουν ζεστές στην αφή έως και 45 λεπτά αργότερα. 
9. Όπου συσκευές ή καλύματα είναι σημασμένα με το σύμβολο αναφερθείται στις οδηγίες χρήσης της συσκευής. 
10. Όλα τα γραφικά σύμβολα που χρησιμοποιούνται σε αυτό το προϊόν είναι από ένα ή περισσότερα από τα έξης πρότυπα: EN61010-1, IEC417 και ISO3864.

## **WARRANTY**

Rosemount Analytical warrants that the equipment manufactured and sold by it will, upon shipment, be free of defects in workmanship or material. Should any failure to conform to this warranty become apparent during a period of one year after the date of shipment, Rosemount Analytical shall, upon prompt written notice from the purchaser, correct such nonconformity by repair or replacement, F.O.B. factory of the defective part or parts. Correction in the manner provided above shall constitute a fulfillment of all liabilities of Rosemount Analytical with respect to the quality of the equipment.

**THE FOREGOING WARRANTY IS EXCLUSIVE AND IN LIEU OF ALL OTHER WARRANTIES OF QUALITY WHETHER WRITTEN, ORAL, OR IMPLIED (INCLUDING ANY WARRANTY OF MERCHANTABILITY OF FITNESS FOR PURPOSE).**

The remedy(ies) provided above shall be purchaser's sole remedy(ies) for any failure of Rosemount Analytical to comply with the warranty provisions, whether claims by the purchaser are based in contract or in tort (including negligence).

Rosemount Analytical does not warrant equipment against normal deterioration due to environment. Factors such as corrosive gases and solid particulates can be detrimental and can create the need for repair or replacement as part of normal wear and tear during the warranty period.

Equipment supplied by Rosemount Analytical Analytical Inc. but not manufactured by it will be subject to the same warranty as is extended to Rosemount Analytical by the original manufacturer.

At the time of installation it is important that the required services are supplied to the system and that the electronic controller is set up at least to the point where it is controlling the sensor heater. This will ensure, that should there be a delay between installation and full commissioning that the sensor being supplied with ac power and reference air will not be subjected to component deterioration.

*Rosemount Analytical and the Rosemount Analytical logotype are registered trademarks of Rosemount Analytical Inc. All other marks are the property of their respective owners.*

## **Emerson Process Management**

**Rosemount Analytical Inc.  
Process Analytic Division**  
6565P Davis Industrial Parkway  
Solon, OH 44139  
T (440) 914 1261  
F (440) 914 1271  
E [gas.csc@emersonprocess.com](mailto:gas.csc@emersonprocess.com)

**Fisher-Rosemount GmbH & Co.**  
Industriestrasse 1  
63594 Hasselroth  
Germany  
T +49 (0) 6055 884-0  
F +49 (0) 6055 884-209  
E [info.de@emersonprocess.com](mailto:info.de@emersonprocess.com)

**EUROPE, MIDDLE EAST,  
AFRICA**  
**Fisher-Rosemount Ltd.**  
Heath Place  
Bognor Regis  
West Sussex PO22 9SH  
England  
T 44-1243-863121  
F 44-1243-845354

**LATIN AMERICA**  
**Fisher - Rosemount**  
Av. das Americas  
Rio de Janeiro, RJ  
Brazil 22631-003  
T 55-21-2431-1882

**ASIA - PACIFIC**  
**Fisher-Rosemount  
Singapore Private Ltd.**  
1 Pandan Crescent  
Singapore 128461  
Republic of Singapore  
T +65 6777-8211  
F +65 6777-0947  
E [AP.RMT-Specialist@emersonprocess.com](mailto:AP.RMT-Specialist@emersonprocess.com)

<http://www.raihome.com>